

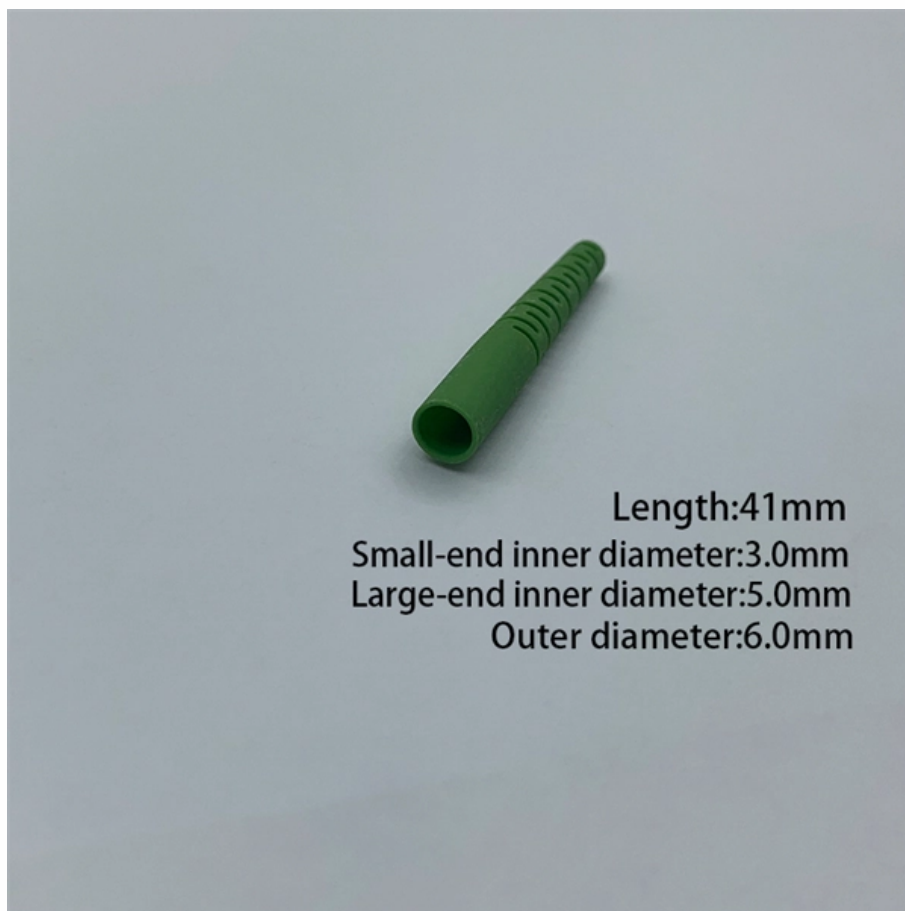

**Adam Tas Corridor Energy**

# **Aerial Optical Cable Method**





## Overview

---

In fact, there are two methods for aerial optical cables laying: one is "fixed-pulley traction method", including "manual traction method" and "mechanical traction method"; the other is "cable tray moving and. An aerial cable is an insulated cable usually containing all fibres required for a telecommunication line, which is suspended between utility poles or electricity pylons. Aerial optical cables are available in a variety of designs to suit every overhead application. 1 This practice covers the basic guidelines for installation of aerial fiber-optic cable. These cables can either be: Lashed cables: Fiber cables attached to an existing messenger wire using lashing wires. Deploying fiber above ground on poles or towers removes the need for underground digging and is particularly useful when the ground is uneven, rocky or both.



## Aerial Optical Cable Method

---

### How to Install Aerial Fiber Optic Cable Systems



Install aerial fiber optic cable systems effectively with expert tips, practical guidance, and key considerations for successful installation.

### Aerial Cable Installation Practices

Individual company practices for placing aerial fiber optic cable should supersede any conflicting instructions in this document when they do not exceed the cable's optical and mechanical



### How to Install Aerial Fiber Optic Cables? , by Orenda

Figure 8 self-supporting aerial fiber optic cables are the common ADSS cables designed for easy and economical one-step installation over long

### Aerial Fiber-Optic Installation: A Key Method in Modern

This approach involves installing fiber-optic cables on existing utility poles, transmission



lines, or other overhead infrastructure. Its popularity comes



## ADSS Fiber Optic Cable, Price And Specifications

We are committed to efficiently meeting a wide range of customer demands for ADSS fiber optic cables. Trusted ADSS aerial fiber optic cable suppliers and

## INSTALLATION OF AERIAL FIBRE OPTIC CABLES

The recommended method to install ADSS cable is the 'Stationary Reel' method. This method requires the reel of cable to be stationed at one end of a pull and a take up reel on the other end.



## How to Install Aerial Fiber Optic Cable

Aerial optical fiber cable is an optical cable laying on poles. This kind of laying method can use the original overhead wiring pole lines, saving construction costs and shortening the construction period.



## Fiber Optic Cables Market 2025

Fiber Optic Cables Market size was valued at USD 8.18 billion in 2024 to USD 11.62 billion by 2032, exhibiting a CAGR of 5.3% during the forecast period

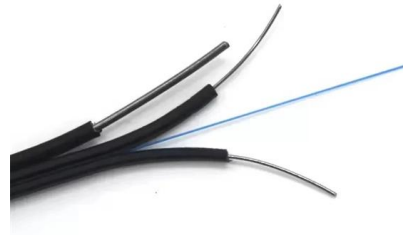

## Aerial Cable , Outdoor Cable Technology, Corning

Aerial outdoor cables are suspended from poles or pylons or mounted on buildings. Some are self-supporting, requiring no separate messenger wire between poles

## IP-003 Aerial Installation Guidelines for Fiber Optic Cable

1.1 This practice covers the basic guidelines for installation of aerial fiber-optic cable. It is intended for personnel with prior experience in planning, engineering, or placement of aerial cable.



## Introduction to Aerial Fiber Cables

Since aerial cables are exposed to harsh outdoor environments and extreme weather conditions, the material used to make them must be sturdy and



## Fiber Installation Costs: Real Numbers for Underground

**Aerial Installation: Lower Upfront Investment**  
Aerial fiber deployment typically costs 40-60% less than underground installation initially. Faster installation and lower



- TELECOM CABINET
- BRAND NEW ORIGINAL
- HIGH-EFFICIENCY



## Aerial Fiber Cable Placing Methods\_New

The methods used to place aerial Fibre optic cables are similar to those used to place copper cable. Optical cable is a high capacity transport medium that is sensitive to excessive tensile force, tight

## The Latest Methods of Aerial Fiber Cable Construction

Many people are confused about the hanging of aerial optical cables. In fact, there are two methods for aerial optical cables laying: one is "fixed-pulley traction method", including "manual





## The FOA Reference For Fiber Optics -Outside Plant

Deploying fiber above ground on poles or towers removes the need for underground digging and is particularly useful when the ground is uneven, rocky or both. Aerial

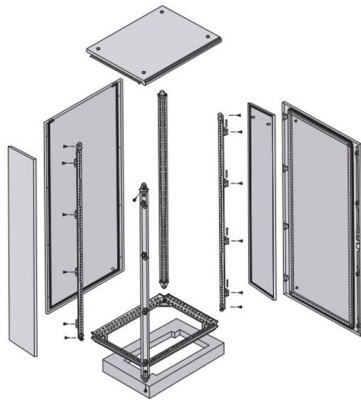

### Aerial Fiber Optic Cable: What it is and How it Works

Aerial fiber optic cable is installed above ground, often on utility poles, while underground fiber optic cable is buried beneath the surface. The main difference lies in their installation methods and visibility.



### Aerial Fiber Optic Cable Overview and Installation Guide

Installing Aerial Fiber Optic Cables Aerial fiber optic cable is installed using a stationary reel or moving reel method. The stationary reel method is best used

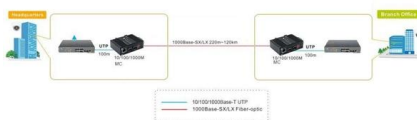

### Aerial Fiber Optic Cable Overview and Installation Guide

According to the installation methods, aerial fiber optic cables can be generally classified as two types--catenary wire and self-supporting: the former is a kind of regular outdoor loose-tube





## Lashed Aerial Installation of Fiber Optic Cable

The following applies to all fiber count gel-free and gel-filled armor ribbon cables installed in aerial plant, including down pole pedestal turn-ups: When jacket opening is made for a splice closure, pedestal,



## Aerial Fiber Optic Cable - Types & Installation Tips

Discover aerial fiber optic cables including ADSS, Figure-8, and OPGW types. Learn key advantages and expert installation tips for reliable



## The FOA Reference For Fiber Optics -Outside Plant

Aerial Cable Installation Aerial Cable Installation Deploying fiber above ground on poles or towers removes the need for underground digging and is particularly

## The Latest Methods of Aerial Fiber Cable Construction

Many people are confused about the hanging of aerial optical cables. In fact, there are two methods for aerial optical cables laying: one is "fixed-pulley traction



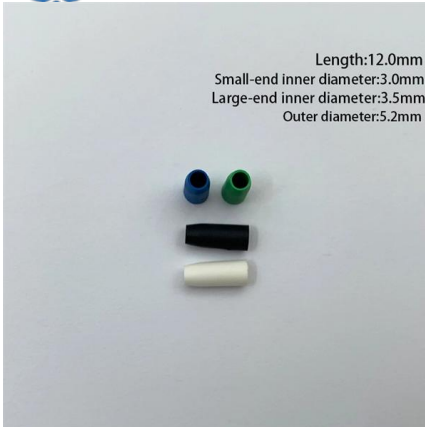

## Aerial Fiber Optic Cable Guide

Aerial Fiber Optic Cable is the smart choice for building reliable networks in both urban and rural areas. Its combination of affordability,

## Aerial Fiber Cable Installation: Types, Hardware

Learn the key types of aerial fiber cables, essential pole hardware, and field-safe installation practices to ensure reliable overhead fiber deployment.

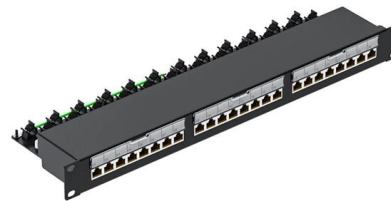

## Aerial Fiber Cable Placing Methods\_New

Aerial optical cable is suspended in the air from poles and/or support structures. Most often it is supported between poles by being lashed to a wire rope messenger strand with a small gauge wire.

## Lashed Aerial Installation of Fiber Optic Cable

an existing lashed fiber optic or copper cable. This method of aerial cable installation, "overlashing," is attractive because the expense of providing a separate suspens





## Aerial Fiber Optic Cable Installation Guide: Hardware

Many different methods are used for cable installation. These include pulling, blowing, and pushing into ducts, direct burial, and aerial installation. In

### Installing Aerial Fiber - What Are the Options?

Cable Termination Methods Like every other fiber cable, aerial cable can be field spliced or deployed pre-terminated. Each method has its pros and cons. For the

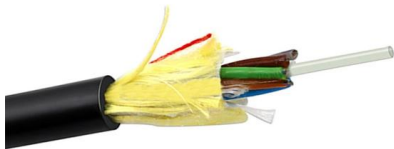

### Aerial Cable Installation Practices

Using this method, the fiber optic cable is pulled into place beneath the strand using cable blocks. Lashing the cable to the strand then begins at the far end of the cable route with the lasher being

## INSTALLATION OF AERIAL FIBRE OPTIC CABLES

The installation methods for fibre optic cables are largely the same as those with conventional copper cables. It is, however, important to observe the limiting values for the cable, given by the cable



## Contact Us

---

For datasheets, pricing, or custom telecom energy solutions, please visit:  
<https://koskolong.co.za>