



**Adam Tas Corridor Energy**

# **Dedicated cable for cable tray connection**





## Overview

---

Tray-rated cables save installation time and money since they can be installed on cable trays or between the tray and the equipment without metal conduit and/or armor. A rung spacing of 6 to 9 inches (150 to 230 mm) is preferable when the cable tray is used for instrumentation and control applications that require it. It is the standard wiring method for industrial plants, commercial buildings, and utility installations where cable trays provide accessible cable runs. The mechanical and electrical characteristics, tests, certifications, overall quality management, and recommendations mentioned in this technical guide only apply to our own cable management ranges and cannot under any circumstances be transposed to silicone, overheating or.



## Dedicated cable for cable tray connection

---



### 100+ Essential Questions Answered About Cable Trays:

Discover over 100 expert answers about cable trays, covering key topics like material selection, load capacity, installation methods, and maintenance.

### Cable Tray Systems: Requirements and Best Practices

Comprehensive guide to cable tray systems requirements: tray types, materials, loading, supports, bonding, routing, and best practices for safe electrical cable management.

#### PRODUCT DETAILS

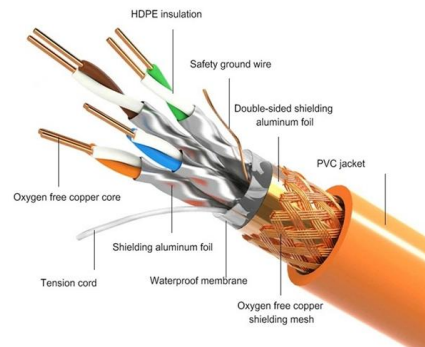

### Types of Cable Typically Used in Cable Tray

TC cables are rated for 600 volts and can be used in industrial power or control circuits, where flame retardant cables are desired. Allowed installations include

### Tray Rated Cable , Bulk Wire & Cable , Products , AutomationDirect

Tray Rated Cable Tray-rated cables save installation time and money since they can be



installed on cable trays or between the tray and the equipment without metal conduit and/or armor. Available



## Comprehensive Guide to Tray Cable Types

Comprehensive Guide to Tray Cable Types. Explore various tray cable types, insulation, and jacket options. Your guide to tray cable and perfect cable.

## Tray Installations

Tray Installations The placement of cables, ducts, and conduits can be done using cable trays - for both outside plant (OSP) and interior spaces (ISP). This allows

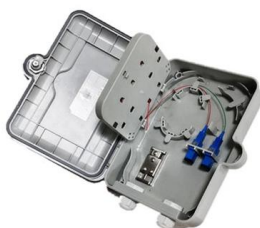

## Cable tray manual

INTRODUCTION The B-Line series Cable Tray Manual was produced by our technical staff. We recognize the need for a complete cable tray reference source for electrical engineers and designers.



## A Comprehensive Guide to Tray Cable

Since cable trays do not fully enclose cables, which would be the case with cable raceway or ducts, tray cable must conform to strict requirements to



## ITER Cabling Handbook

The local trays indicate the support of one or several cables (in limited number) from the main cable tray to the electrical equipment to connect (around 5 m). These local trays have generally a width of 50 or

## Equipment Grounding Conductors for Cable Tray Systems

Cable tray wiring systems have excellent safety and dependability records. These excellent records are the result of cable tray's unique features plus the proper



## Guide to cable support systems

Widths of 8 and 15 millimetres enable flexible adjustment to different cable trays, cable ladders and cable volumes. With the help of the matching SBV tightening strap locks and 576 spring chuck, the



## Master Cable Tray Installation: A Professional Step-by

Learn how to install cable trays for large-scale projects with our professional, step-by-step guide covering industry standards, safety protocols,

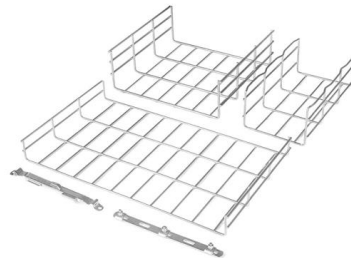

## Cable tray manual

Instead of large conduits, cable channel may be used very effectively to support cable drops from the cable tray run to the equipment or device being serviced and is ideal for cable tray runs involving a

## Cable Tray Installation

Learn everything about cable tray installation with our complete guide. Discover types, steps, and safety tips for efficient electrical cable management.



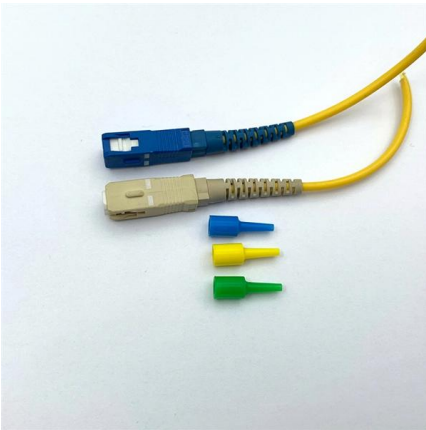

## Cable Tray Installation Guidelines , PDF , Galvanization

This document provides details on installing cable trays and their support systems. It includes diagrams showing how to mount cable trays on walls using pre

## The Ultimate Guide to Tray Cables: Types, Applications and

Tray cables (TC) are multi-conductor cables designed and rated for installation in cable trays and raceways or supported by messenger wires. Unlike standard electrical cables, tray cables feature



## Practices for grounding and bonding of cable trays

A bare copper equipment grounding conductor should not be placed in an aluminum cable tray due to the potential for electrolytic corrosion of the aluminum cable tray in a moist environment. For such

## The Ultimate Guide to Tray Cables: Types, Applications and

When it comes to powering, automating and protecting facilities?from factories and petrochemical plants to data centers and high-rises?the right cable makes all the difference. Among the various



## Tray Cable Applications & Selection Guide , TC, TC-ER, VNTC, EPR

Complete guide to tray cable types including TC, TC-ER, VNTC, EPR-CPE, and shielded instrumentation cable. Compare constructions, NEC requirements, and applications for industrial,



## Cable Tray Types and Sizes

Explore various cable tray types and sizes for electrical installations. Learn about ladder, perforated, solid-bottom, wire mesh, and channel trays in this complete



## A Technical Guide to Tray Cables , OneMonroe Titan

Tray cables are versatile and durable electrical cables used for power, control, and signal transmissions in various industrial environments. They are specifically designed for installation in



## GUIDE CABLE TRAYS TECHNICAL

NEMA VE 1-2017 Specifies requirements for metal cable trays and associated fittings designed for use in accordance with the rules of Canadian Electrical Code, Part I and the National Electrical Code®

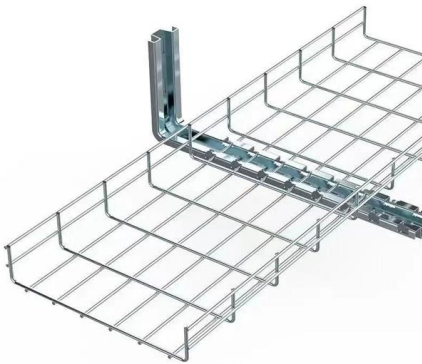

## CABLE TRAYS CONNECTION INSTRUCTIONS

It is possible to use cable trays as grounding conductor equipment. In accordance with National Electrical Code (NEC) Article 392 "Cable trays" first determine the Maximum Fuse Ampere Rating or

## Practices for grounding and bonding of cable trays

Grounding and bonding of cable trays There are three wiring options for providing an EGC in a cable tray wiring system: An EGC conductor in or on

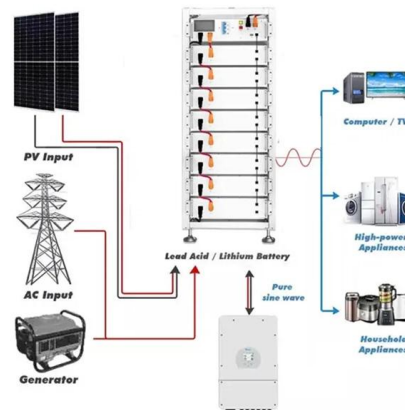

## Complete cable tray manual for electrical engineers and

Complete cable tray manual for electrical engineers and designers (on photo: power cable management ladder tray systems assembled aluminum cable tray ladder



### **Cable Tray Technical Guide A practical guide to product selection and**

Cable Tray Technical Guide A practical guide to product selection and installation This guide for engineers and installers has been developed by ABB as a practical reference regarding cable tray

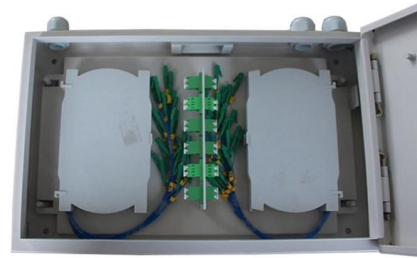

### **Cable Tray Technical Guide A practical guide to product selection and**

Cable tray installed in a hazardous location must contain only those cables that are appropriate for this type of environment as defined in Chapter 5 of the NEC.



### **tonga-outdoor-cable-tray-price , B2B companies and suppliers**

24 Companies and suppliers for tonga-outdoor-cable-tray-price Find wholesalers and contact them directly Leading B2B marketplace Find companies now!





## **Cable Pathways: A Data Center Design Guide and Best**

Cable Pathways: A Data Center Design Guide and Best Practices Cables may not be the most glamorous part of the data center, but they certainly



## **Contact Us**

---

For datasheets, pricing, or custom telecom energy solutions, please visit:  
<https://koskolong.co.za>