

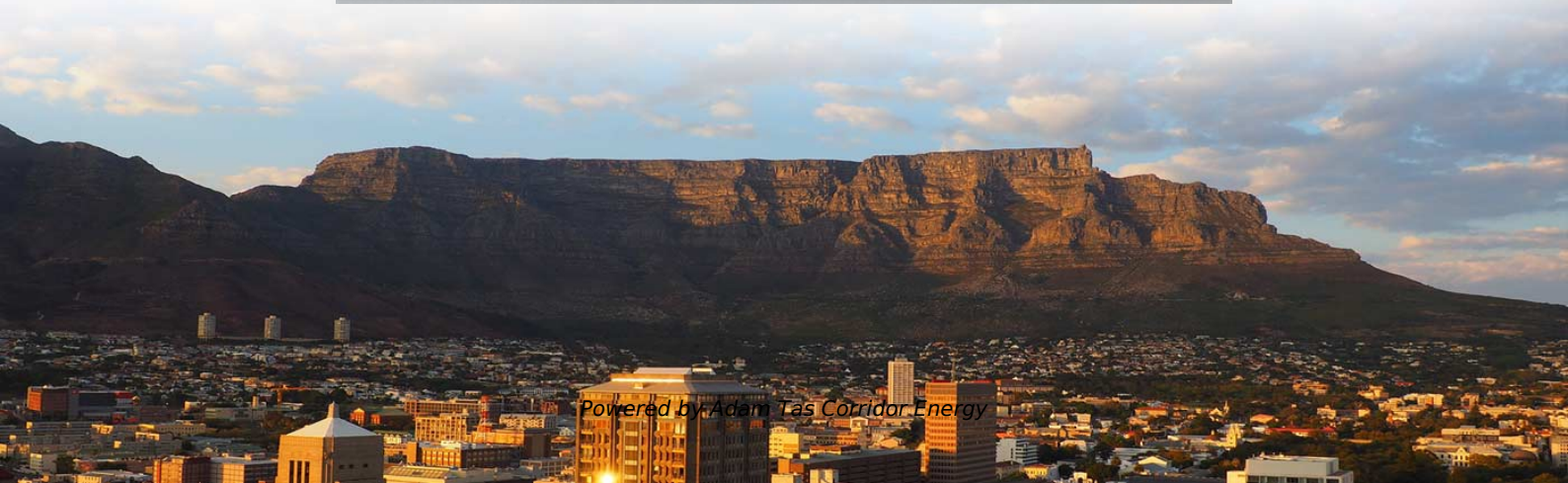

Adam Tas Corridor Energy

Do fiber optic cable junction boxes come directly from manufacturers





Do fiber optic cable junction boxes come directly from manufacture

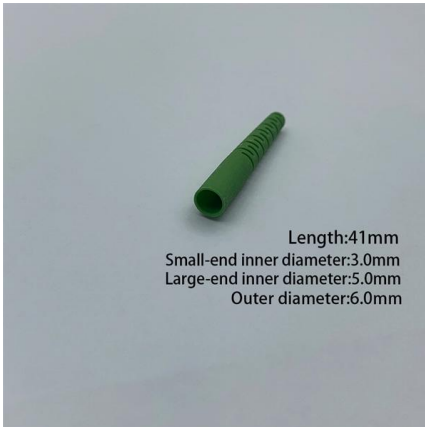

An In-Depth Exploration of Fiber Optic Distribution

It begins with an introduction to fiber optic technology and the pivotal role of distribution boxes in managing fiber optic cables. The article categorizes the

Fiber Terminal Box vs. Junction Box: What's the Difference?

Learn the difference between a fiber terminal box and a fiber junction box, including functions, applications, capacity, and installation scenarios. ZION Communication provides a

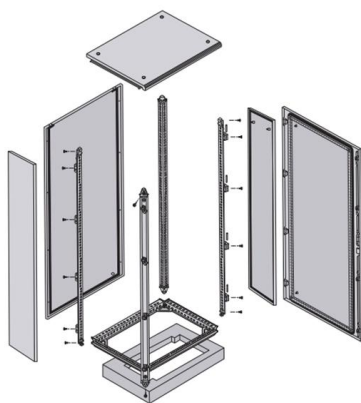

Fiber Junction Box: Your Guide to Installation, Types,

Discover the world of Fiber Junction Boxes! Explore installation tips, different types, and the advantages they offer. Get expert insights for seamless

Fiber optic junction box, Fiber optic terminal box

Find your fiber optic junction box easily amongst the 67 products from the leading brands



(HUBER+SUHNER, BOPLA, METZ CONNECT,) on DirectIndustry, the



INTOS ELECTRONIC AG -FTTH junction boxes

The four integrated LC sockets allow the connection of multiple fiber optic cables - for example, to supply four apartments or end devices via a central patch panel.



Fiber Box Manufacturer & Supplier

Our company has a professional technical team, and our product line includes a variety of fiber optic terminal boxes and fiber distribution boxes, designed to meet



Fiber Optic Distribution Box (FDB) Manufacturer , 2-48 Core Outdoor

Yes, distribution boxes can be either wall-mounted or rack-mounted, depending on the specific model and installation requirements. Wall-mounted boxes are often used for smaller installations, while rack





Fiber Optic Splice Closure, Electrical Cable Junction

The fiber splice box is suitable for the straight-through and branch connection of the overhead, pipeline, direct burial and other laying methods of various layout fiber



Fiber Optic Distribution Box FAQs

A Fiber Optic Distribution Box is a device used for fiber optic cable joint fusion, connection and distribution. It can easily connect multi-core and single-core fiber

The Types of fiber Optical Terminal Boxes and How to

A box that comes with clear installation instructions and is easy to access for maintenance will save time and effort in the long run. By considering

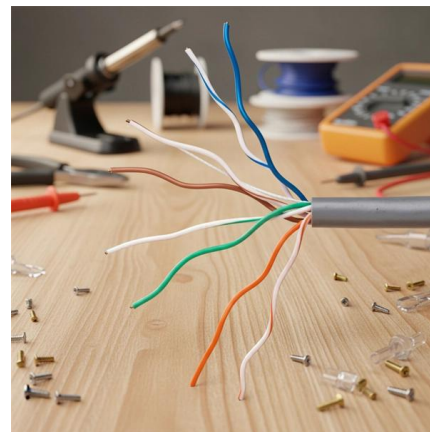

FTTH Technology: Fiber optic cable, pigtails & boxes for your FTTH

To help you optimally equip your FTTx network, EFB-Elektronik offers a complete range of fiber optic accessories. From MDIC (micro-drop installation cables) to fiber optic pigtails and connecting

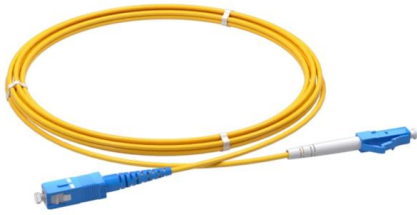

Fibermint , High-Quality Fiber Optic Enclosures

From standardized fiber optic closures to custom-designed distribution boxes, Fibermint delivers reliable connectivity protection through

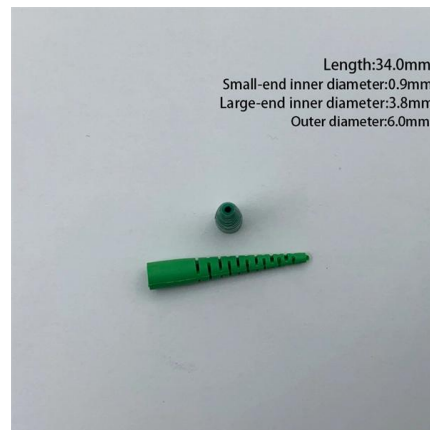

Fiber Termination Boxes: A Beginner's Guide to

Cable Entry and Management: Carefully route the incoming and outgoing fiber optic cables through designated entry points, utilizing cable

Essential Guide to Optical Cable Junction Boxes: Key Benefits & FAQs

Understanding Optical Cable Junction Boxes
Optical cable junction boxes play a crucial role in managing and organizing fiber optic networks.





FS Community

Hier sollte eine Beschreibung angezeigt werden, diese Seite lässt dies jedoch nicht zu.

Fiber Optic Junction Boxes , Products & Suppliers , GlobalSpec

Find Fiber Optic Junction Boxes related suppliers, manufacturers, products and specifications on GlobalSpec - a trusted source of Fiber Optic Junction Boxes information.

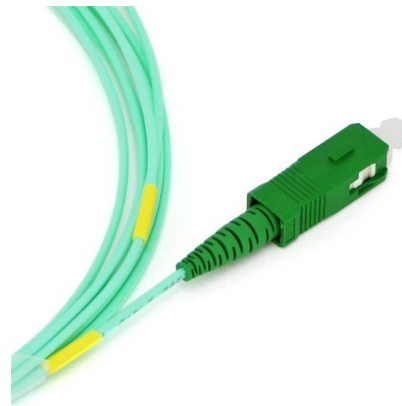

Fiber-Optic Junction Boxes , New Equipment Digest

MICRONOR 's MR398-JB series fiber-optic junction boxes are designed to join two fiber-optic cables and environmentally protect the connection. The product



Fibermint , High-Quality Fiber Optic Enclosures Manufacturer

From standardized fiber optic closures to custom-designed distribution boxes, Fibermint delivers reliable connectivity protection through



How to Choose the Right Optical Junction Box?

Consider the following: The number of fiber cables that need to be connected. The environment in which the junction box will be installed (indoor vs. outdoor). The level of protection



Metal Fiber Optic Distribution Box

The metal optical fiber cable distribution box is a box that helps distribute the fiber between floors and offices. It can be used to bring light into a specific area, or it



Fiber Optic Distribution Boxes (FDB) & ODF Supplier

OTRANS is a leading fiber optic distribution box manufacturer. We offer a wide range of 1-24 core FDB boxes and ODF cabinets for indoor/outdoor FTTX deployment.





What is a Fiber Connection Box? , Fiber Optics - Sivo

A fiber connection box, also known as a fiber optic junction box, termination box, or distribution box, is a crucial component in fiber optic networks. It houses and protects the



Fiber Terminal Boxes: What They Are and Why You

A fiber terminal box, is a device used in fiber-optic communication networks to terminate, splice, and distribute optical fibers. It is a small enclosure

Outdoor Rated Fiber Distribution Boxes FDU's - Primus Cable

Outdoor Fiber Distribution Boxes With the changing seasons presenting new challenges for your fiber optic network to overcome, Primus Cable offers Outdoor Fiber Distribution Boxes that are designed

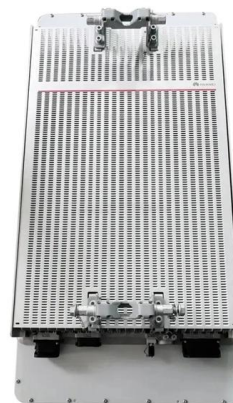

Termination Box For Fiber Optic Cable

Discover everything know about termination box for fiber optic cable, their functions, and how they connect in network setups. Perfect for network professionals!



Contact Us

For datasheets, pricing, or custom telecom energy solutions, please visit:
<https://koskolong.co.za>