



**Adam Tas Corridor Energy**

# Dual Router for Core Switch





## Dual Router for Core Switch

---

### What Is a Core Switch?

A core switch is the backbone of a large-scale network, designed to handle massive volumes of traffic with ultra-low latency and maximum reliability. Sitting at the top of the hierarchical model, core



### MikroTik CCR2116-12G-4S+ 16-Core 10G Cloud Router

MikroTik CCR2116-12G-4S+ 16-core Amazon Annapurna Labs CPU at 2 GHz, 4x 10G SFP+, 13x GbE, 16 GB RAM, Layer 3 hardware offloading, dual PSU, M.2 slot.



### Core switch to dual ISP routers

Hi, I am looking for some design help. We currently have dual routers ISP1 and ISP2 and plan to connect them to a single layer 3 core switch. I am trying to decide what way to go with the

### Stack or separate core switching (x690)

We're going to install two 48 port SFP+ switches at a co-location facility that will house all of our



primary servers and storage. Both x690 switches have the core licence and will do layer 3. Our

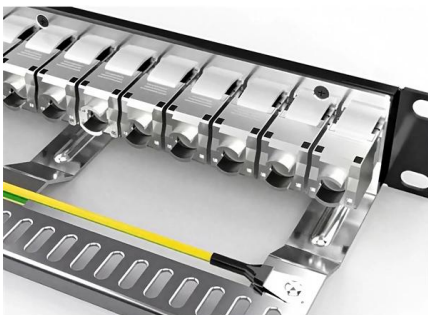

### **Asus RT-AC68U Dual Band Gigabit Router JRS Eco-wifi firmware**

Hallo, wir hatten diesen Router wegen der deutlichen Strahlungsminimierung angeschafft. Leider ist ,Asus RT-AC68U Dual Band Gigabit Router JRS Eco-wifi firmware in Hessen - Herborn

### **Dual ISP's into the core switch**

The Core switch is a cisco 4500, currently we have dual PIX515's on our current feed, the new feed will be using ASA's. @Nerdmedic: We already



### **Understanding the Core Switch: Key Differences and Uses**

Explore the core switch's role as the backbone of your network. Discover key differences, uses, and insights into layer 3 core switch technology.



## Edge switch redundancy to two core switches

I want to provide best redundancy for an access switch (Cisco 3650) when connecting to two core switches (Cisco 9500 series), as show in attached

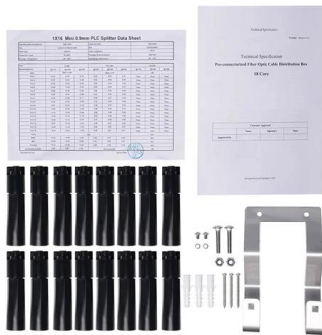

## Core layer , FortiSwitch 7.6.0 , Fortinet Document Library

With 8x100-GbE QSFP28 slots per FortiGate unit, it provides enough capacity to directly connect with 2x100-GbE ports to each of the two core FortiSwitch units at a nonstop forwarding capacity of up to

## Solved: core switch redundancy

Hi, school with around 800 users having one core switch 6509-E sup-720 (inter-vlan routing) collapsed core design connected to - 30 layer 3 HP



## Network with inter vlan routing

Each switch will need a default route to core switch 1 and a second default route with higher metric to router 2. Failover will only occur if a link

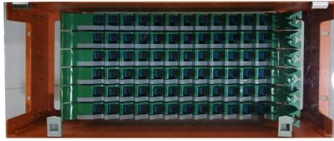

## Ubiquiti UniFi Dream Machine Special Edition

Die Ubiquiti UniFi Dream Machine SE ist ein leistungsstarkes Netzwerkmanagement-Gerät mit 1,7 GHz Quad-Core-Prozessor und integriertem PoE-Switch. Sie bietet

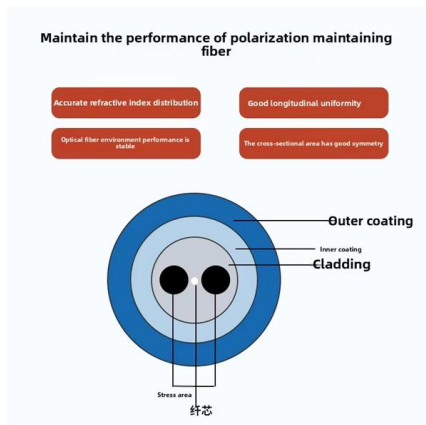

## Two-Tier Core

Configure Two-Tier core switches as a VSX pair for Layer 2 aggregation of the data center access switches, IP data center services, and routing to the main campus.

## What is optimal way to connect two core switch/routers

We have two 4507s at our core, running HSRP. We have three other 4507s at the edge, plus eight 2950s. All edge switches and WAN routers are connected to both core 4507s. We have a Port-Group

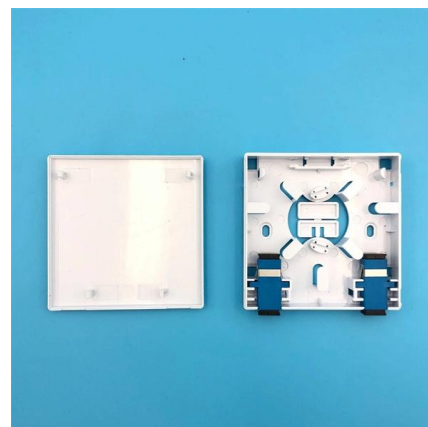



## Cisco Catalyst 2960-X and 2960-XR Series Switches

This data sheet describes the benefits, specifications, and ordering information for the Cisco Catalyst 2960-X Series Switches.

### Dual Core Design

You can have two core routers with redundant connection to the core switches. One router can host a connection to the primary ISP, while the second one hosts a back up circuit.

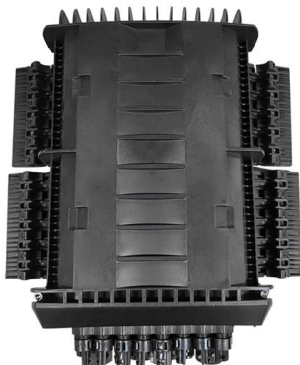

### Routing on firewall or core switches? : r/networking

In my research I'm getting mixed suggestions - Some say that core switches are for routing, when others say that core switches have to be as fast as possible and have minimal tasks

### TP-Link ER8411 Enterprise Wired 10G VPN Router

TP-Link ER8411 Enterprise Wired 10G VPN Router - Up to 10 WAN Ports, High Network Capacity, SPI Firewall, Support Omada SDN, Load Balance, Lightning

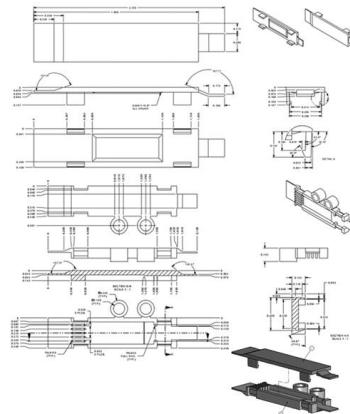



## Solved: Redundancy with two switches core

Hello everyone, I have a customer who has just bought two switches core (L3), his today diagram network is: Access Switches come to one Switch Core



## What is Core Switch and How to Choose?

Discover what a core switch is and learn how to choose the right one for your network. Explore key features in selecting a core layer switch. Make



## Connecting Multiple switches to core : r/networking

I've worked in large manufacturing facilities where the Core is connected to Distribution switches and they connect the standard layer 2 access switches. My boss was always on at me "upgrade the core"

## Understanding Core Switch: What It Is and How to

In the realm of system networking, three key types of switches are frequently mentioned: access switches, aggregation switches, and core switches.

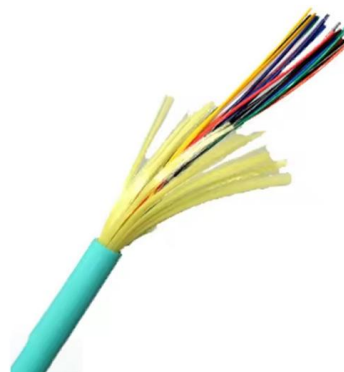



## Dual Core Design

Need clarification on dual core switch design. Should be a pretty easy question, but the dual core design is just 2 core routers instead of one. Is this what they mean by dual core design? Enterprise

## FS Community

Hier sollte eine Beschreibung angezeigt werden, diese Seite lässt dies jedoch nicht zu.

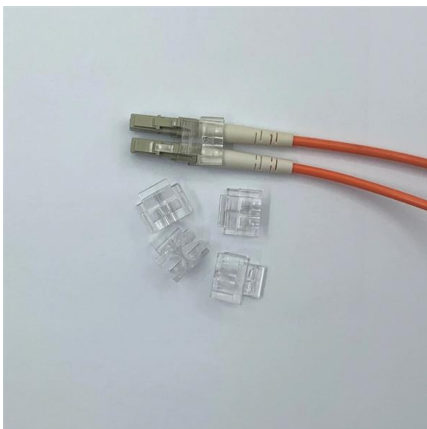

## Core Switch Explained: Key Functions and Benefits

Core switches are crucial in effective network design. They stand at the network's heart, speeding up data transfer across different segments. Unlike edge switches, core switches are the

## GitHub

This lab demonstrates a redundant, segmented enterprise network integrating HSRP (Hot Standby Router Protocol), Layer 3 switching, and NAT-enabled Internet access.



### **MikroTik Router Switch CRS210-8G-2S+IN**

Verkaufe 6 Stück Cloud Router Switch 210-8G-2S+IN Er verfügt über acht Gigabit Ethernet Ports, zwei SFP+ Einschübe für 10G Konnektivität (Der erste



### **What is a Core Switch , Functions and Difference over Normal Switch**

What is a core switch and how it works? This article builds the basics of this kind of switch for the ones who don't know anything about it. What is a Core Switch? It is a powerful



### **core switch or multiple switch to router : r/networking**

Is there any advantages and disadvantages to connecting each of those switches to port 1-5 on the router? With a core switch, I can connect all 5 of those switches to it and trunk the core switch to the



## Contact Us

---

For datasheets, pricing, or custom telecom energy solutions, please visit:  
<https://koskolong.co.za>