



Adam Tas Corridor Energy

Emergency Plan for Electric Shock to Communication Cables





Emergency Plan for Electric Shock to Communication Cables



4 Electric shock: First aid procedures

4 Electric shock: First aid procedures + This poster contains basic advice on first aid for use in an emergency. It is not a substitute for effective training.

Emergency Response Procedure

Where there may be a risk of electrocution it is important that all staff are aware of the safest way to deal with electric shock/electrocution to ensure both themselves



ITPro Today, Network Computing, IoT World Today combine

ITPro Today, Network Computing and IoT World Today have combined with TechTarget . The page you are looking for may no longer exist.

U.S. News: Latest Breaking Stories and Video on

Get the latest news headlines and top stories from NBCNews . Find videos and news articles on



the latest stories in the US.



First Aid for Electric Shock or Electrocutation

FIRST AID FACT SHEET How to treat electric shock An electric shock occurs when a person comes into contact with an electrical energy source. Electrical energy flows through a portion of the body

Complete Electrical Emergency Response Plan Guide

As a trusted electrical service provider since 1965, Highland Electric knows that having a well-designed emergency response plan for electrical



First Aid Response for Electrical Shock Incidents

First Aid Response for Electrical Shock Incidents: Learn the correct first aid steps for treating electrical shock victims, including how to safely





Electrical Emergency Response Plan , SafetyDocs PDF

This Electrical Emergency Response Plan template will help your Electrical business meet legal duties and establish clear responsibilities for electrical safety in the



Electrical Risk Emergency Response Plan , PDF , Burn

The document presents an emergency response plan for electrical risk that includes the identification of electrical risk areas, emergency response methods, and procedures for notification and

First Aid for Electric Shock Guidelines

First Aid for Electric Shock Guidelines As part of the local area induction, all staff and students must be made aware of the location of first aid kits and a list of local First Aiders.

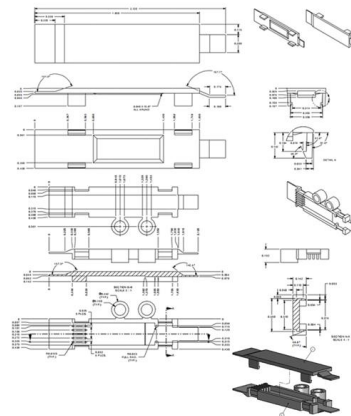

Essential Emergency Procedures for Electrical Incidents

Let's look at the main steps to take during electrical incidents, as well as ways to prevent them and follow safety rules.

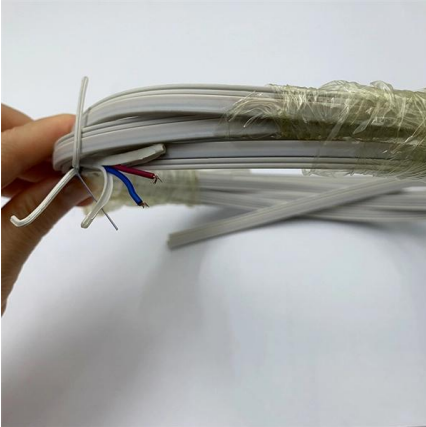

How to Plan for an Electrical Emergency in the Workplace

Learn how to integrate electrical safety into your emergency response plan. Discover strategies to protect your team.

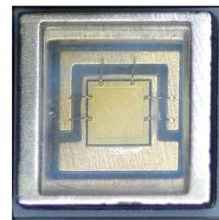

Electrical shock: First aid

An electrical shock may cause burns, or it may leave no visible mark on the skin. In either case, an electrical current passing through the body can cause damage inside the body, cardiac

Emergency Response Plan for Electrical Incidents

Learn how to report and document electrical incidents at construction sites, and how to prevent them from recurring with an effective emergency response plan.





Electric Shock First Aid Fact Sheet

Electric shock Even ! for a mild electric shock, encourage the patient to seek medical aid for assessment of potential effects on the heart.

4 Ways to Treat a Victim of Electrical Shock

To treat a victim of electrical shock, start by calling emergency services immediately. Then, while you wait for them to arrive, place the victim in the recovery position to ensure that their airway remains clear.

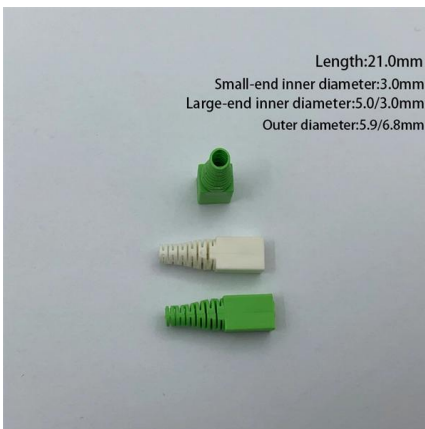
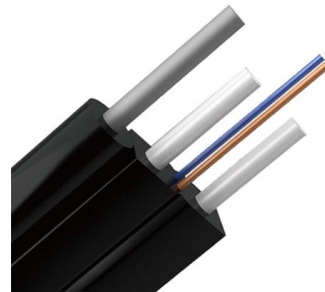

Electric Shock Emergency Response: A Lifesaving

Electrical shock incidents can be life-threatening, but a swift and informed response can make all the difference. Here's a detailed guide on how to

Emergency Response during Electrical Safety

If a victim is still conscious after having been shocked, they need to be closely monitored and cared for until trained emergency response personnel arrive.



Emergency Preparedness in Electrical Contracting:

Discover why emergency preparedness in electrical contracting is vital for safety, compliance, and reliable project delivery.

Electrical Injury Emergency Response

Electrical Injury Emergency Response some content courtesy of US Department of Energy More Information DOs and DON'Ts o DO include the emergency response plan in the job briefing.

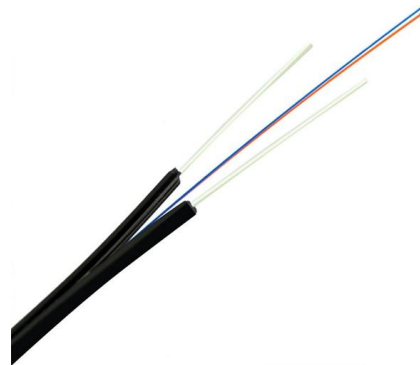

Electric Shock Emergency Response Plan

The document outlines an emergency rescue plan and mock drill for an electric shock scenario. It describes the objectives to train employees on how to respond





Complete Electrical Emergency Response Plan Guide

Remember, the best emergency plan is one you never need to use. That's why Highland Electric emphasizes preventative maintenance and proper



Responding to Electrical Shock Incidents , HSENation

Electrical shock incidents can be life-threatening emergencies that require immediate and appropriate response. This safety talk aims to equip you

Emergency Response Plans for Electric Shock Incidents

Every moment counts after an electric shock incident. Here's what you should include in your emergency response plan.



Emergency Response , Electrical Safety , Electronics

If a victim is still conscious after having been shocked, they need to be closely monitored and cared for until trained emergency response personnel arrive.



Electric Shock: Symptoms, First Aid Treatment, Long

Electric shocks can range from mild to severe. We'll go over how to handle shocks on both ends of the spectrum -- when you or someone you're with

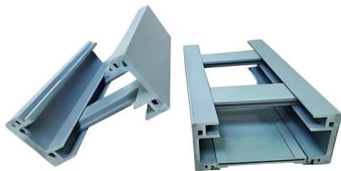

Responding to Electrical Shock Incidents , HSENation

Responding effectively to electrical shock incidents requires knowledge, preparation, and quick action. By following the steps outlined in this

Electrical Emergency Preparedness: Guide for

Electrical emergency preparedness is critical to workplace safety, especially for contractors and trades workers. This guide provides valuable

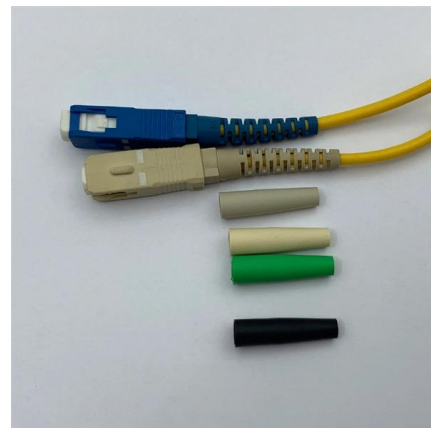



Contact Us

For datasheets, pricing, or custom telecom energy solutions, please visit:
<https://koskolong.co.za>