



Adam Tas Corridor Energy

FC fiber optic interface adapter





FC fiber optic interface adapter

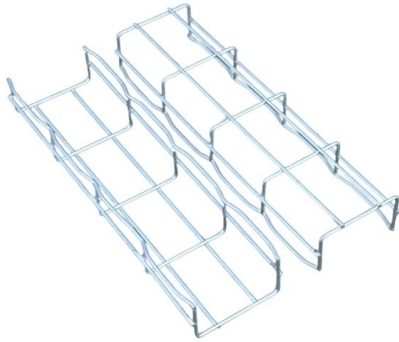

FC-FC-Adapter , Edmund Optics

Die Adapter für optische Fasern sind Anschlusssteckeradapter, mit denen sich ein Kabel durch Verbindung von zwei optischen Fasern mit Stecker mit geringen Kupplungsverlusten verlängern lässt.

Amazon : Fiber Light Tester

Visual Fault Locator 30KM - VFL Fiber Optic Tester Kit Include Single Mode 9/125um FC Male to LC Female Adapter, Fiber Optic Lights for Network Cable (Battery not Included) 400+ bought in past

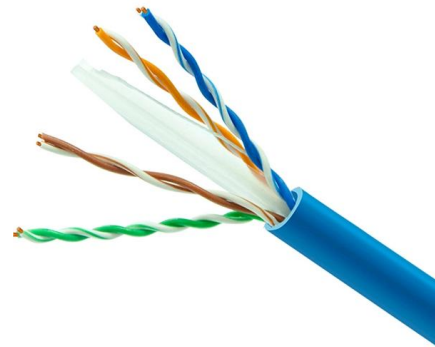

FC Bare Fiber Optical Adapter For Field Termination

The FC Bare Fiber Optical Adapter is designed to facilitate the connection of bare optical fibers to other fiber optic equipment. It is compatible

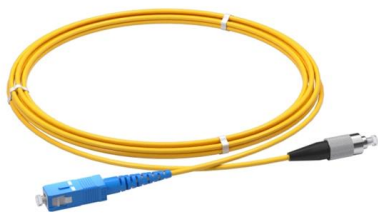

FC Connector Adapter (FC-FC)

Fiber Connector Adapters are receptacle-type adapters designed to extend cable length by joining two fiber optic patch cords together with



low coupling loss.

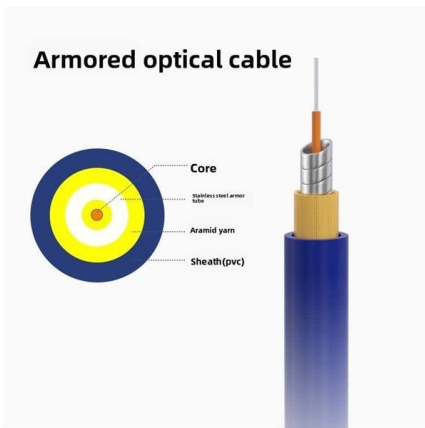
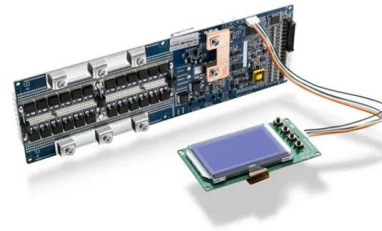

100Pcs Ceramic Sleeve ST/FC Universal Fiber Optical Adapter Port

26.96 USD Car FM Transmitter Adapter Bluetooth 5.0 Type-C Dual USB Fast Charger Adapter 10.78 USD 100Pcs Ceramic Sleeve ST/FC Universal Fiber Optical Adapter Port Interface v Product

Fiber Optic Patch Panel , ODF Optical Distribution

Optimize your network management with our high-density Fiber Optic Patch Panels and ODFs. Available in 1U/2U/4U rack mount and wall mount configurations,

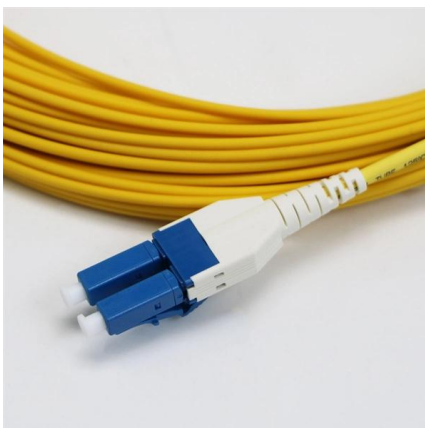

Fiber Optic Connectors & Ceramic Ferrules , SC, LC, FC, ST, MPO

Upgrade your network performance with our professional-grade Fiber Optic Connectors. Featuring high-precision Zirconia Ceramic ferrules for minimal signal loss, our selection includes industry-standard



Fiber Optic Connector Adapters , Connectors,

Shop DigiKey's large in-stock selection of Fiber Optic Connector Adapters. View inventory, pricing and order now for same day shipping!



Amazon : Fiber Optic Tester

Portable 5-in-1 Fiber Optic Cable Tester with Optical Power Meter, Cable Finder, Visual Fault Locator & RJ45 Network Cable Test, SC/FC/ST Universal Interface with LC Adapter



FC Fiber Optic Adapters , Amphenol-Fiber Optic Products

Discover Amphenol FOP's high-precision FC fiber optic adapters-available in bulkhead, feed-through, and flange mount designs, offering durable zirconia and phosphor bronze sleeves.



Durable FTTH Terminal Box , Fiber Termination

Explore reliable FTTH terminal boxes for secure fiber termination and distribution. Wall-mounted design, robust build, for home and industrial optical networks.



Fiber Optic Connector Kits (Updated Daily) , Adorama

Shop Fiber Optic Connector Kits at Adorama for reliable connections, easy installation, and top brands. Perfect for pro audio and video needs!



SFP Fiber Optic Connector Types: LC, SC, MPO Explained

Explore common SFP fiber optic connector types, including LC, SC, and MPO/MTP. Learn their differences, use cases, and compatibility.

FC Adapters , Fibertronics, Inc.

Fibertronics offers a variety of FC adapters that are available in single mode & multimode as well as simplex with round & square types for flange mounts.





15 Best Optical Power Meters for Fiber Techs in 2025 --

Here's a comprehensive guide to the 15 best optical power meters for fiber techs in 2025, offering expert insights and reviews to help you find the



Adapter Fiber Optic Connector Interface SC/UPC/FC/UPC ST/UPC

Adapter Fiber Optic Connector Interface SC/UPC/FC/UPC ST/UPC LC/UPC (1PC LC UPC) : Amazon.ca: Industrial & Scientific Fields with an asterisk * are required Price



Adapter Fiber Optic Connector Interface SC/UPC/FC/UPC ST/UPC

Adapter Fiber Optic Connector Interface SC/UPC/FC/UPC ST/UPC LC/UPC (1PC FC UPC) : Amazon.ca: Industrial & Scientific Fields with an asterisk * are required Price

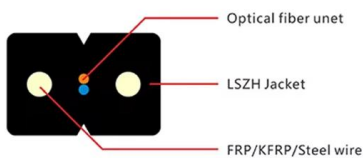

LC Fiber Optics: The Ultimate Guide to High-Density, High

Explore high-performance LC fiber optic solutions including connectors, patch cables, adapters, patch panels, and attenuators. Optimize your data center and enterprise networks with



HJ Outdoor Fiber Optic Terminal Box Metal Wall Mount Waterproof

Q: What is this product used for?A: This optical cross-connect box is designed for fiber optic network distribution, cross-connection, and terminal management in outdoor and indoor applications.



Optical fiber connector

An optical fiber connector is a device used to link optical fibers, facilitating the efficient transmission of light signals. An optical fiber connector enables quicker



Adapter Fiber Optic Connector Interface SC/UPC/FC/UPC ST/UPC

Adapter Fiber Optic Connector Interface SC/UPC/FC/UPC ST/UPC LC/UPC (2PCS FC UPC) : Amazon.ca: Industrial & Scientific Fields with an asterisk * are required Price





FC Connectors and Adapters , OEM Optical Communication Solutions

We also provide an FC fiber coupling adapter family to support FC-PC interconnection. Corning's FC adapters are available in a wide range of hybrid adapter styles to fit almost any application or panel

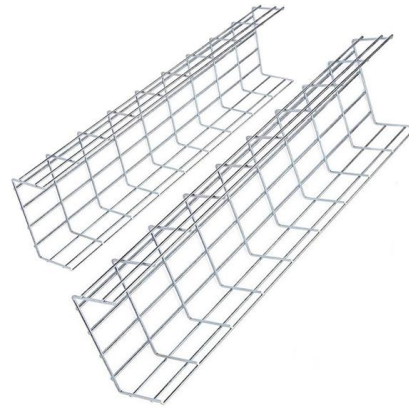

Fiber Optic Adapters -- Simplex, Duplex, Hybrid , TTI Fiber

Fiber Optic Adapter Seamless Alignment
Simplex, duplex, and hybrid adapters for LC, SC, FC, and ST -- precision ceramic and bronze sleeve options.

2 x M16 FC Fiber Optic Adapter Conversion Heads

Compatibility : This fiber optic adapter conversion head supports FC connectors, allowing for a seamless connection between different fiber interfaces and optical power meters or light sources. Precision



Amazon : Fiber Optic Tools

Portable 5-in-1 Fiber Optic Cable Tester with Optical Power Meter, Cable Finder, Visual Fault Locator & RJ45 Network Cable Test, SC/FC/ST Universal Interface with LC Adapter

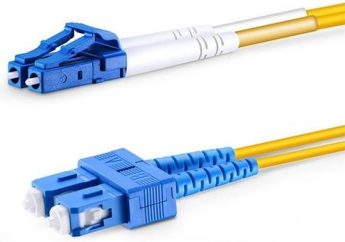

Amazon : Fiber Optic Power Meter

Equip your fiber optic toolkit with a versatile power meter. Measure optical power, detect breaks, and test network cables with these compact, portable devices.



FC Adapters: Functionality, Applications, Selection

FC adapters are key components in fiber optic communication systems. They are used to connect two FC connectors, enabling the transmission

Fiber Adaptor FC/APC male

Delivery time: 1 - 3 Workdays (DE - int. shipments may differ) Pcs Add to basket This is a fiber optic adapter with an FC/APC connector to an FC/PC port, Simplex, Singlemode





FC SC ST LC Male to Female Fiber Optic Connector FTTH Single



Wide Compatibility: Support various types of interface, such as FC, SC, ST and LC, suitable for a wide range of fiber optic networking equipment and systems. Adaptable to various environments:

FEMTO®

The PRA series fibre connection adapters extend FEMTO photodetectors with free-beam input and threaded flange (FST) with FC/PC, FC/UPC, FC/APC, or FSMA

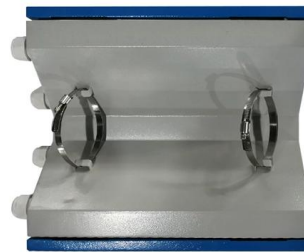

Contact Us

For datasheets, pricing, or custom telecom energy solutions, please visit:
<https://koskolong.co.za>