

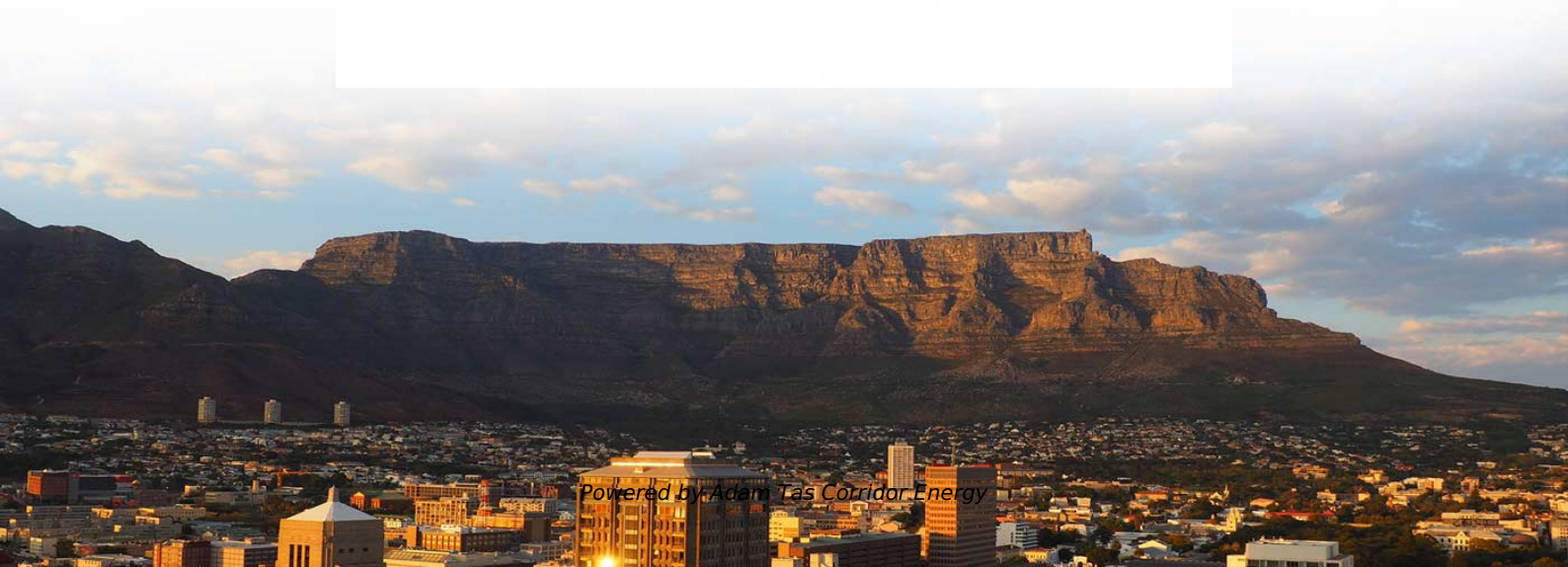

Adam Tas Corridor Energy

High Voltage Variable Frequency Complete Equipment Manufacturer

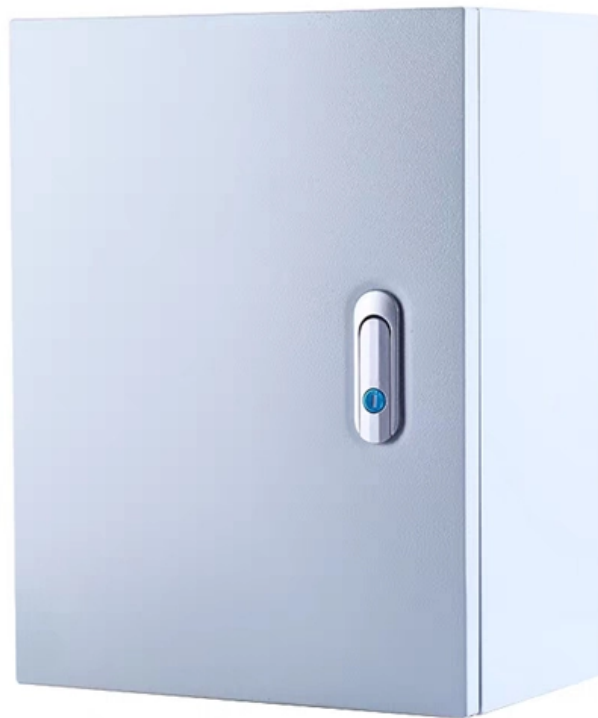



High Voltage Variable Frequency Complete Equipment Manufacture

Home , Innomotics

Experience advanced motors, drives and digital intelligence that accelerate your path toward higher efficiency and confident decisions.

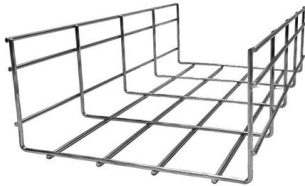

High Voltage Test Equipment

HV TECHNOLOGIES provides a complete and broad range of High Voltage Test Equipment and Service Solutions for the Utility and Electrical Power Industries.

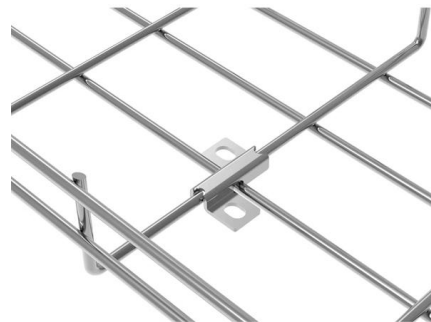

- Full Customization Support
- Free Design & Fast Sample Service
- Eco-friendly & Certified Materials
- Strict Quality Control

SGS CE ISO 9001:2015
BSCI GCC

Variable Frequency Drives (VFDs) , Rockwell Automation , US

Your production demands the reliability of PowerFlex® variable frequency drives (VFDs). Our low voltage and medium voltage VFDs are

HE1000 High Voltage Variable Frequency Selection Guide

It has the perfect harmony function and meets the application requirements of various industrial



fields. Micno is engaged to providing high voltage variable frequency, and energy-saving drives with the



High-frequency power supply

Find your high-frequency power supply easily amongst the 52 products from the leading brands (Kikusui, Voita, Wisman,) on DirectIndustry, the industry



Top 15 Variable Frequency Drive Manufacturers

Whether you're managing a complex manufacturing line or a simple irrigation system, selecting the right variable frequency drive manufacturer is



What is a variable frequency drive? , Danfoss

What does VFD stand for? A variable speed drive. Using VFDs you can typically reduce energy use of fans and pumps by 40%. Here, Danfoss explains how a





Variable Frequency Drive Manufacturers: ABB, Eaton, Lenze, and

The WJ200 Variable Speed Drive comes with an integrated auto-tuning function for easy sensorless vector control that provides high starting torque of 200% or greater, suitable for a variety

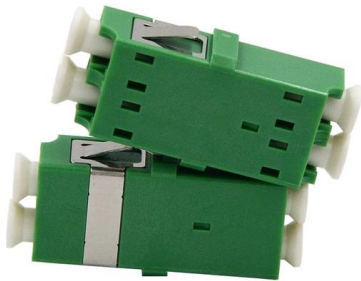

VFD Company List: Top Manufacturers & Suppliers of

Explore our comprehensive VFD company list featuring the top manufacturers and suppliers of variable frequency drives (VFDs) worldwide. Find

Variable Frequency Drives (VFDs): Benefits, Sizing

A variable frequency drive VFD converts constant utility power into adjustable voltage-frequency output, so the motor runs only as fast as required.



Variable frequency power supply and frequency converter

Variable frequency power supply: Constant frequency during startup. Shore power supply can provide pure and reliable, low harmonic distortion, high stability of voltage and frequency sine



Top 17 VFD Manufacturers , Variable Frequency Drive

Top 17 VFD (Variable Frequency Drives) Manufacturers A Variable Frequency Drive (VFD) is an advanced motor control device used to regulate the speed and torque

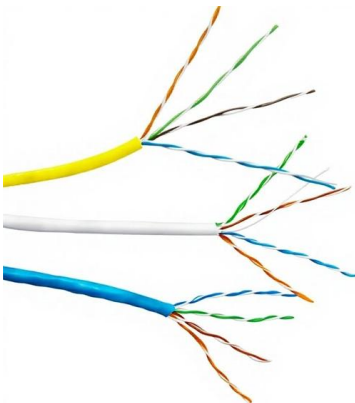
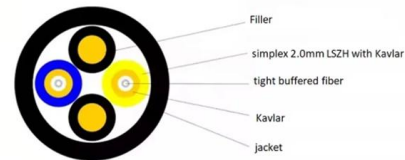

High Voltage Equipment (High Voltage Machines)

Use our special service form and enter your search query for High Voltage Equipment. We will then search for the right manufacturer, dealer or service provider for High Voltage Equipment and forward

High-Performance VFDs , Low & High Voltage Variable

Browse our complete portfolio of Low Voltage and High Voltage Variable Frequency Drives in one place. Compare series and find the latest innovations in motor





Drives , ABB

ABB Drives ABB Drives is a global technology leader serving industries, infrastructure and machine builders with world-class variable speed drives, drive systems and packages. We help our

High Voltage AC Drive, Controller, VFD, VSD Inverter Manufacturer

As the leading VFD manufacturer, VEICHI Electric provides a full range of products such as high voltage ac drive at wholesale price. If you need high voltage ac drives for your system, then you've already

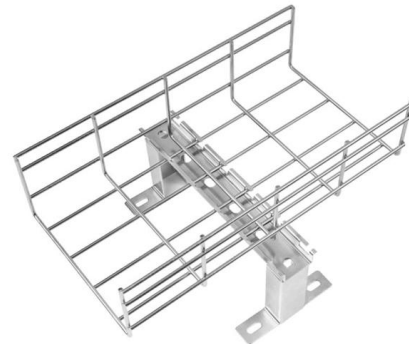

Hipotronics , Hipotronics

Hipotronics is a global leader in manufacturing high voltage test and measurement equipment for a range of markets and applications.

Top 15 Variable Frequency Drive Manufacturers

Final Thoughts on Variable Frequency Drive Manufacturers The global VFD market is diverse and evolving rapidly. Whether you're managing a complex



AC Variable Frequency Converter Drive/Speed

Variable Speed Drive As a China variable speed drive manufacturer, MICNO offers a wide range of inverter variable speed drives including low voltage, medium



Homepage , WEG

WEG provides global solutions for electric motors, variable frequency drives, soft starters, controls, panels, transformers, and generators.



Variable Frequency Drive (VFD): The Complete Guide

Complete VFD guide covering working principles, types, and applications. Learn how Variable Frequency Drives can reduce energy costs by





100 manufacturers for Variable Frequency Drive (VFD)

Hiconics is a variable frequency drive supplier, over 20 years in developing, manufacturing & selling medium voltage & low voltage drives. As the No.1 manufacturer of VFD in China, Hiconics is aiming



MORE CASES PRESENTATIONS



Variable Frequency Drives (VFDs) , Rockwell Automation , US

Your production demands the reliability of PowerFlex® variable frequency drives (VFDs). Our low voltage and medium voltage VFDs are engineered to deliver precise speed, torque and direction

High Voltage Power Supply

For high voltage applications, our state-of-the-art technology is designed to meet demanding needs, including military and defense-related applications. As a trusted high voltage power supply



Home Page , Monitra

At Monitra, we supply a comprehensive range of equipment suitable for the condition assessment of in-service medium voltage (MV), high voltage (HV) and extra high voltage (EHV) power cables,



Contact Us

For datasheets, pricing, or custom telecom energy solutions, please visit:
<https://koskolong.co.za>