



Adam Tas Corridor Energy

How is the network cabinet powered





Overview

Network cabinets work with rack-mounted PDUs to deliver power in a clean, organized way. Power cables are routed neatly, making it easier to manage loads and perform maintenance. Whether you're setting up a new office or streamlining an existing network, understanding the importance, types, and usage of network cabinets is crucial. Understanding Data Center Power Flow is critical for engineers, contractors, and facility designers working on mission-critical infrastructure. The aim is a secure, maintainable and scalable operation of the network environment.



How is the network cabinet powered

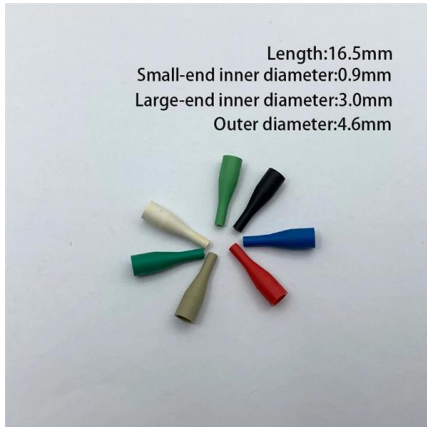

Backup power options for a small networking cabinet?

HomeNetworking is a place where anyone can ask for help with their home or small office network. No question is too small, but please be sure to read the rules before asking for help. We also welcome

What is A Network Cabinet and how to choose it

Network cabinet is tall, breathable frame designed to organize various devices efficiently. Its structured layout maximizes floor space and keeps server

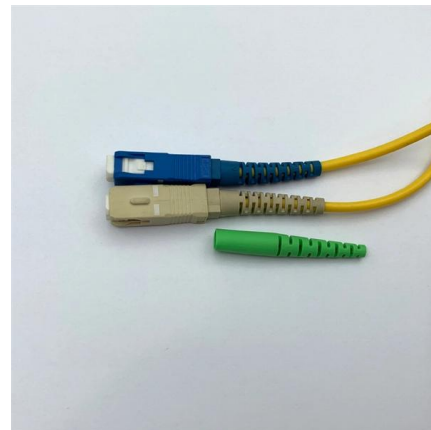

What Is the Network Cabinet Systems, and How Do

Network cabinet systems come in different series with different structures designed for different requirements. So, knowing how each one works and what benefits it

A Quick Overview Of Network Cabinets And Their

Are there any drawbacks to using network cabinets? One of the best qualities of a network



cabinet manufacturer is their ability to innovate.
A skilled



A General Overview Of Network Cabinets And Their

Are Their Cons Of Using Network Cabinets?
Innovation is one of the best features of a network cabinet manufacturer. An experienced individual



What are the primary functions of a network cabinet in an IT

Without a well-organized and functional network cabinet, an IT network could face challenges related to space, safety, cooling, and overall management. In this article, we will explore



Network Cabinet Cabling: Guide & Documentation Tips

Practice-oriented guide to network cabinet cabling with documentation template, safety aspects & software tips.

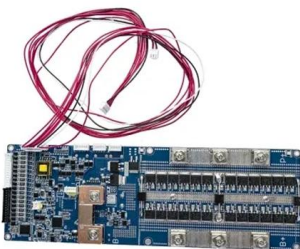



What is a Network Cabinet (Rack) and Why You Need

Discover what a network cabinet (rack) is, why it's essential and how to choose the right type (wall mount vs floor mounted closet).



Exploring the Role of Network Cabinets in Modern IT

Network cabinets work with rack-mounted PDUs to deliver power in a clean, organized way. Power cables are routed neatly, making it easier to

The Ultimate Guide to Setting Up a Home Network

The home network wiring cabinet is a dedicated space in your house where you can organize and centralize all the necessary equipment and connections for your



What is a Network Cabinet (Rack) and Why You Need

If you're new to networking or wondering whether you need a network cabinet, this beginner's guide will help you understand what they are, how they



PDU: the data cabinet center of power ~ NetworkTigers

PDU's are considered the backbone of data centers and networks as they provide reliable power to connected servers.



Data Center Power Flow: Utility to Server Rack Explained

Data Center Power Flow explained step by step, from utility power and generators to UPS systems and server rack distribution.

A Technical Guide to the WightFibre Cabinet

The Active Cabinets are powered and there is resilience in power provision too with each cabinet having their own dual power feeds. The cabinets also have an Uninterruptible Power Supply (UPS) built in





The Ultimate Guide to Network Cabinets: Everything You Need to Know

"A network cabinet is a metal shelter used for apprehending networking devices like routers, switches, patch panels and servers." Such enclosures assist you in systematizing as well as

What Is a Cabinet PDU and Why ESTEL Leads the Market

A cabinet PDU ensures efficient power distribution in data centers, enhancing uptime, energy efficiency, and scalability for modern IT infrastructure.



How to Properly Install and Set Up a Network Cabinet

Installing and setting up a network cabinet system correctly is essential for maintaining an efficient and organized network infrastructure. In this

Practical Advice for Selecting Cabinet Power Distribution

Choose the right cabinet power distribution unit for your data center by considering power needs, outlet types, certifications, and future scalability.



How do network cabinets work?

These cabinets can integrate environmental sensors to monitor temperature and humidity, as well as power distribution units (PDUs) for remote

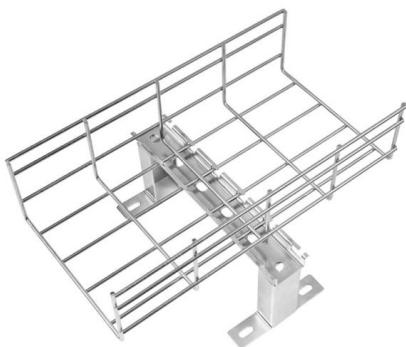

Network Cabinets: The Essential Guide for Your IT Infrastructure -

In today's digital age, businesses depend on their IT infrastructure to stay connected and efficient. A critical part of this setup is the network cabinet, which keeps your networking equipment safe and



What is A Network Cabinet and how to choose it

Since network racks and cabinets are built to house equipment with lots of cables, cable management is even more important in a network rack or





What Is the Network Cabinet Systems, and How Do

See which network cabinet system fits your needs. Network cabinet systems come in different series with different structures designed for different requirements. So,

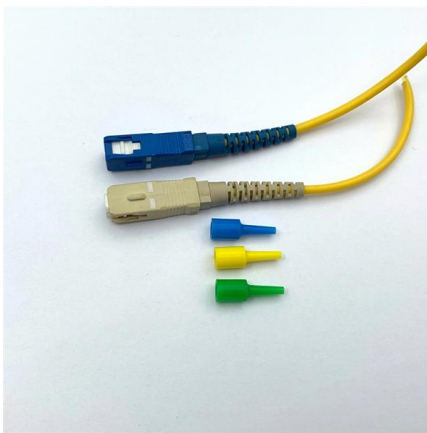

Network Cabinet Essentials: Organizing Your Network

A network cabinet, is a physical frame or enclosure designed to house and organize various types of network hardware and accessories. These include

A comprehensive guide to telecom racks and cabinets

Learn more about the vital role of telecom racks and cabinets play in ensuring seamless connectivity and network efficiency.



Network Cabinets: The Essential Guide for Your IT Infrastructure -

As demand for data storage and cloud services rises, network cabinets are more important than ever. Check out the table below to see how the global data center rack market, including network cabinets,



Optimizing Data Center Infrastructure: Network

Types of networks cabinets. Freestanding data cabinets- Have rolling wheels for easy relocation or movement around. Wall-Mount cabinets/racks are

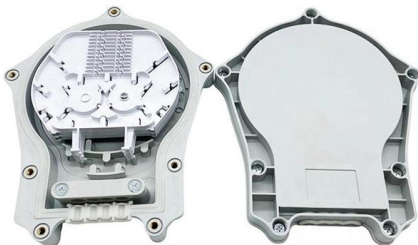

Network Cabinet Essentials: Organizing Your Network

Discover the pivotal role of a Network Cabinet in managing IT infrastructure. Learn about types, technical features, and best practices.

Network Cabinet: Complete Guide for the Best Choice

Choosing the Network Cabinet is crucial to ensure the organization, safety, and efficiency of IT equipment. A well-selected cabinet not only optimizes



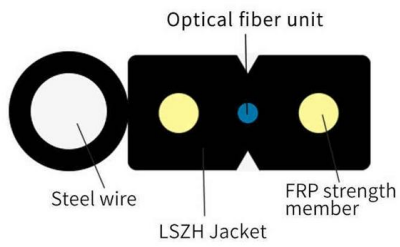

What Is A Network Cabinet and What Is The function of

Here are some of the irreplaceable benefits that network cabinets bring: · Optimize the structure of a server system: The network cabinet is usually

Contact Us

For datasheets, pricing, or custom telecom energy solutions, please visit:
<https://koskolong.co.za>