



Adam Tas Corridor Energy

How to install cable tray tees facing upwards





How to install cable tray tees facing upwards



Cable Tray Tees: Pre-Galvanised Medium Duty Equal Tee

Cable Tray Tees provide a smooth, reliable way to branch out your cable runs while keeping everything organised and secure. Whether you're directing cables to different sections of a building or creating

Solved: Cable Tray Orientation

Does anyone know how to place cable tray on a wall so that the open end of the tray is facing into the room? I have tried inserting a fitting first, rotating that so it is facing the right way and

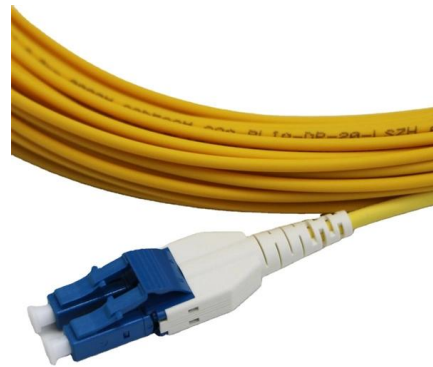

Cable tray manual

These documents: ANSI/NEMA VE-1, Metal Cable Tray Systems; NEMA VE-2, Cable Tray Installation Guidelines; and NEMA FG-1, Non Metallic Cable Tray Systems, are an excellent industry resource in

How to install a cable tray to a wall?

The edge of the cable tray is lifted onto the straight tip of the bracket. The other edge of the



How to install Cable Trays - Best Guide in 2026

Step-by-step on-site guide: learn how to plan, mark, support, and install cable trays correctly, from shop drawing approval to final checks.

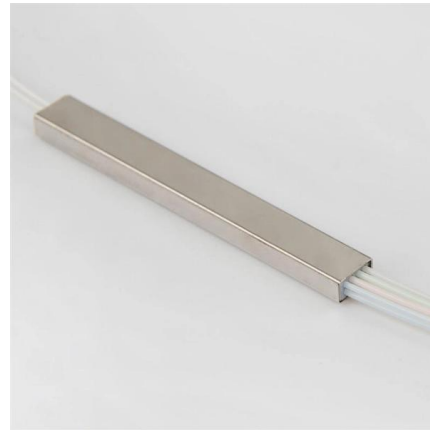

how to install cable tray systems ? , What is the difference between

What is the difference between cable ladders and cable trays? Cable tray use for easier to lay new cables onto a tray system as the needs of a project change over time. ladder tray, cable runway

Cable Tray Technical Guide A practical guide to product selection and

A practical guide to product selection and installation This guide for engineers and installers has been developed by ABB as a practical reference regarding cable tray characteristics, installation, and



CustomFit Cable Tray: Guided Installation , UPLIFT Desk

With the CustomFit Cable Tray, you'll have the best-in-class standing desk cable management. In this video, we guide you through the installation of the UPLIFT Desk CustomFit Cable Tray, designed

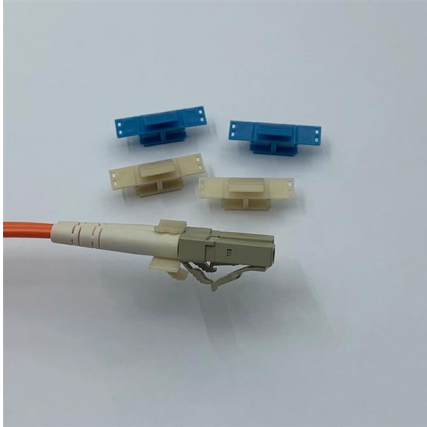

Mastering Cable Tray Installation , Step-by-Step Guide for a Seamless

Mastering cable tray installation is crucial for creating a safe, organised, and efficient cable management system. By following this step-by-step guide, you can ensure a seamless setup that



Master Cable Tray Installation: A Professional Step-by

Learn how to install cable trays for large-scale projects with our professional, step-by-step guide covering industry standards, safety protocols,

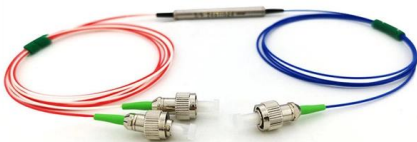

Metal Cable Tray Installation Guidelines , Cable Tray Institute

The Cable Tray Institute is making available the current edition of this practical guide for the proper installation of aluminum or steel cable tray systems. These guidelines will be useful to engineers,

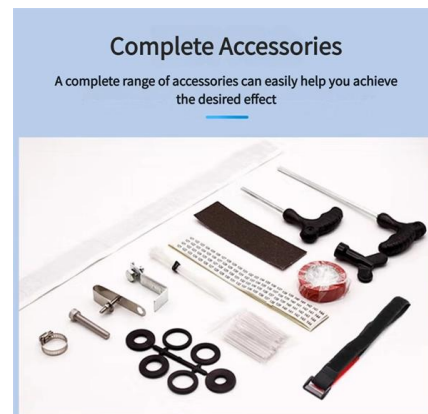



Cable Tray Installation

Learn everything about cable tray installation with our complete guide. Discover types, steps, and safety tips for efficient electrical cable management.



Cable Tray Spacing Standards for Installation and Safety

Key Factors Impacting Cable Tray Spacing
Understanding cable tray spacing is key to meeting safety regulations and maintaining system



How to install a cable tray to a wall?

Wall supports RVK are used for mounting 40 mm height KR-type cable trays to wall, mounting rails AS, ceiling supports HK1, HK2 and TP2 from the inner side of the

Best Practices for Installing Cables in Trays

Quick Installation Checklist (Key Steps) Cable tray cable installation generally follows these steps: Inspect cables before installation Prepare and

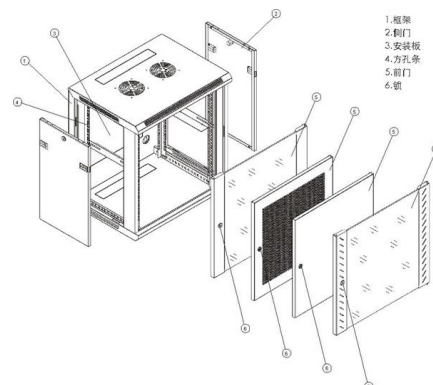



How To Install Cable Tray Ceiling Supports

There are several threaded rod hanging options that can save you time and money. Also learn about your options for wire support systems.

How to Install Cable Tray: A Comprehensive Guide to

Welcome to our step-by-step guide on installing cable trays! In this video, we'll explore the different types of cable trays available and provide

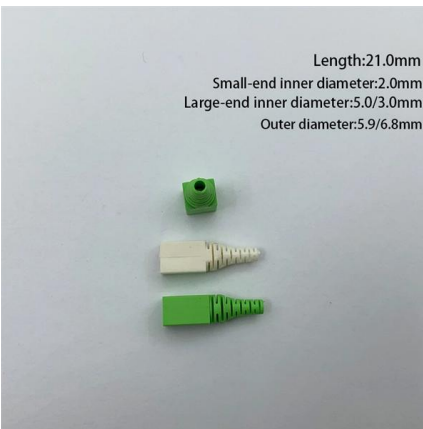

5 Simplified Steps To Install a Cable Tray

By following these steps, you can ensure a safe, stable, and well-organized cable tray installation.

How to Install cable tray Practical Skills

In the electrical wiring of buildings, a cable tray system is used to support insulated electrical cables used for power distribution, control, and communication. cable tray sizes chart cable tray



Ordering information

NO.	1	2	3	4
Model	F3401	F3502	F31203	F31804
Product name	Patch Panel	Patch Panel	Patch Panel	Patch Panel
Illustration				
HU	1	2	3	4
Maximum number of cores	96	192	288	384
Product size (including mounting modules and accessories)	482.0*288.7*43.7mm	482.0*288.7*88.3mm	482.0*288.7*132.9mm	482.0*288.7*177.5mm
Standard color code	RAL9005	RAL9005	RAL9005	RAL9005



How To Install Cable Tray On Wall: A Step-By-Step Guide

Learn how to install a cable tray on a wall with this comprehensive guide. Step-by-step instructions, tools needed, and safety tips included.

Cable Tray Installation

Whether you're building a commercial setup or upgrading an industrial plant, proper cable tray installation ensures neat wiring, safe access, and easy maintenance. But before you lay the first tray



A Guide to Installing and Supporting Electrical Cable Trays

This guide covers the critical steps, from selecting the right electrical cable tray and performing accurate cable fill calculations to managing a safe cable pull through





Contact Us

For datasheets, pricing, or custom telecom energy solutions, please visit:
<https://koskolong.co.za>