



Adam Tas Corridor Energy

How to reinforce cables in a distribution box





How to reinforce cables in a distribution box



Understanding Distribution Boxes: A Comprehensive Guide

A distribution box, also known as a power distribution box or electrical distribution box, is used to distribute electrical power safely to multiple

How To Secure Wiring in An Electrical Box , Best Practice

As a DIYer, it can be intimidating working with metal electrical boxes. But I'm going to show you a common mistake that people make when wiring them



12 cores fiber splice box ftth fiber optic distribution box

A termination box is a distribution box specially designed for the management of fiber cables. Its core use is to terminate fiber optic cables and connect the cable's core

Cable Distribution Box Layout: 10 Industrial Strategies

Optimize your cable distribution box layout for safety and efficiency. Learn industrial best



practices using Chuanli's IEC-standard outdoor and custom boxes.



Guide to cable strain relief and protection

Protect your fibre, ethernet and cables from strain to prolong their lifespan. Here are your options and how to use them correctly.

Wiring Best Practices: A Guide to Distribution Boards

As the heartbeat of any electrical system, distribution boards play a crucial role in ensuring a safe and efficient power supply. Whether you're a homeowner,



Power Distribution Box

Be sure that the power distribution box has sufficient power provided to it. Long cable runs can result in a voltage drop, which can be solved by using a heavy gauge wire.



Wiley Online Library , Scientific research articles, journals, books

Hier sollte eine Beschreibung angezeigt werden, diese Seite lässt dies jedoch nicht zu.



Optical Cable Distribution: Efficient How-To Guide

Learn how to efficiently manage and distribute optical cables using a fiber distribution box. Explore protective sheath and organized distribution.

Tying Electrical Cables: A Pro Guide to NEC Compliance

Learn NEC-compliant methods for tying electrical cables. Our guide covers tools, ampacity charts, and NFPA 70E safety protocols. Read more.

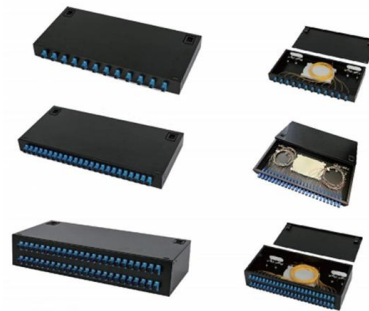

DDS

Hier sollte eine Beschreibung angezeigt werden, diese Seite lässt dies jedoch nicht zu.



How to Install a Distribution Box--A Comprehensive

What is a Distribution Box? First of all, you need to have a simple understanding of the definition of a distribution box, and make it clear which kind

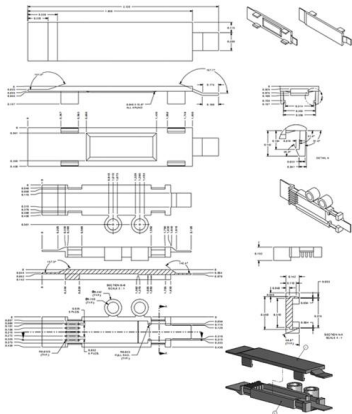

Wire Strain Relief Methods , Cable Strain Relief Solutions

Wire strain relief methods protect cables from mechanical stress, pulling forces and environmental damage at connection points. These solutions range from threaded cable glands that

The installation requirements for the distribution box

Use cable ties or channels to keep things in place, and avoid letting wires cross over each other unnecessarily. Also, make sure every wire is properly





7.5mm Radius

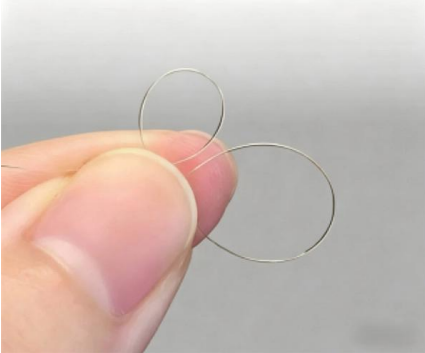

The Complete Guide to Distribution Box: Installation, Types & More

What's the difference between a distribution box and a sub-panel? A distribution box typically refers to the main electrical panel that receives power from the utility service. A sub-panel is

POWER CABLE INSTALLATION GUIDE

Southwire Company's Power Cable Installation Guide provides installation information for extruded dielectric power cable systems. This guide covers copper and aluminum conductors from No. 14

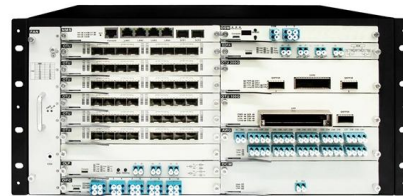

How to install a Structured Wiring + Cable Distribution Box

How to install a Structured Wiring + Cable Distribution Box All About Home Electronics 163K subscribers Subscribe

Integrated wiring fiber optic distribution box installation tutorial

The optical fiber distribution box allows people to easily access the optical fibers in the box, and can well protect the optical fibers. In addition, the drawer structure also facilitates high



Distribution Box Installation: A Complete Guide to Safe

The distribution box, often referred to as a breaker box, fuse box, or electrical panel, is a critical component of any electrical system. It acts as the central hub for



OVERHEAD DISTRIBUTION LINE REPAIR MANUAL, EN-TM-1002-4

Almost all distribution conductor damage occurs at support points. The need to detect the damage early and repair it properly has led PLP to publish this Repair Manual.



The Best Solution to Install Components Inside The

The trickiest part of installing inner components of a distribution box is that the components' heights are irregular. E-Abel's flexible mounting bracket can

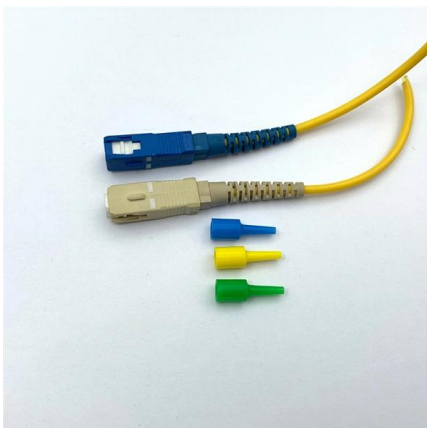



525-2016

Abstract: The design, installation, and protection of wire and cable systems in substations are covered in this guide, with the objective of minimizing cable failures and their consequences.

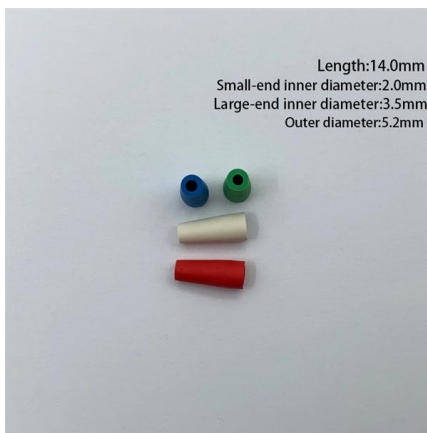

Cable Strain-Relief: Design Tips for Durability and

We will explore the significance of cable strain-relief, its primary functions, various strain-relief types, and design tips that enhance both durability and aesthetics.

Distribution Box Wiring Steps

?Preparation phase? ?Box installation?: Make sure that Distribution box has been correctly installed and fixed. ?Material preparation?: Prepare the required cir



Power Distribution Line Repair: Essential Maintenance Techniques

Here are some important maintenance guidelines to maximize the reliability of power distribution lines. Acquire knowledge of effective repair techniques, establish regular inspection



Ultimate Guide to Transmission & Distribution Cables In

Transmission and distribution cables are designed to carry electrical energy over long distances while minimizing losses. Power distribution cables specifically



The installation requirements for the distribution box

Learn how to install a distribution box safely and correctly. Covers wiring, placement, standards, and expert tips for a compliant setup.

ITER Cabling Handbook

Cable tray sections must be in accordance with the cable types and/or the number of cables installed in it, respecting the maximum filling ratio, according to the cable tray type.





Home Distribution DB Box Wiring Connection Diagram



Welcome to our channel ?@Electricalgenius? In this video, we'll take you through a detailed step-by-step guide on wiring a home distribution DB (Distribution Board) box.

Electric distribution box wiring tutorial (very simple and practical)

In this video, we are going to wire a power distribution box. This small box has an rccb switch that protects the outputs from electric shock and also has a miniature switch that protects the

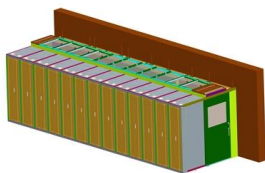

POWER DISTRIBUTION BOX ASSEMBLY GUIDE

Thank you for purchasing the Powersafe Power Distribution Box Phase 3's Powersafe Sequential Mating Box controls the connection sequence of incoming / outgoing high current cable connections. The

The installation requirements for the distribution box

Here are some important maintenance guidelines to maximize the reliability of power distribution lines. Acquire knowledge of effective repair

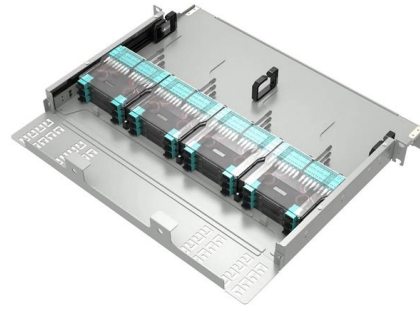

Contact Us

For datasheets, pricing, or custom telecom energy solutions, please visit:
<https://koskolong.co.za>