



**Adam Tas Corridor Energy**

# **Installation of German Cable Distribution Boxes**





## Installation of German Cable Distribution Boxes

---

### Electrical Distribution Boxes for Power Distribution



Unlike conventional installation, you can lay the lines first and install the distribution box at a later time. The robust sheet steel housing protects the sensitive

### CURRENT DISTRIBUTORS

Using the types of distributor described in the equipment standards, it is possible to set up a power supply solution from the feed-in point from the public grid all the way to the consumer connection

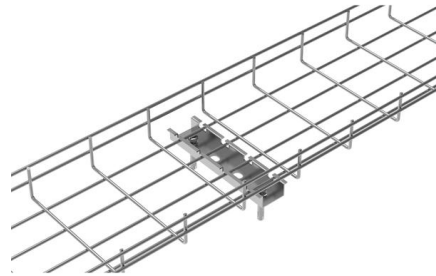

### dominic-electrical-distribution-boxes-for-sale Service provider

All suppliers for dominic-electrical-distribution-boxes-for-sale Service provider Find wholesalers and contact them directly B2B marketplace Find companies now!

### DISTRIBUTION BOX SMART INSTALLATION

Our distribution boxes serve as a link between automation and field level and thus form the



interface for decentralized pluggable electrical installation.



**LoRawan outdoor base station**

- \* Industrial Internet gateway
- \* Compatible with LoRaWAN network,
- \* ClassA/B/C mode
- \* Support 8/16 channel
- \* Supports PoE power
- \* supply and backup battery power supply
- \* 10KV lightning protection



## Mounting and installation information for junction boxes

Taking the above-mentioned parameters into account, protected installation of the junction boxes is essential and also described in detail in the erection standards.

## Germans do the PERFECT Electrical Wiring! (Garage Build)

So let me show you how German electricians do such work and maybe I can inspire you for your next electrical installation.



## Microsoft Word

To reduce the impedances of loops and ensure correct distribution of currents in parallel conductors, single-pole cables and isolated conductors belonging to the same circuit must be laid directly beside



## Size determination, installation method and wiring mode

The distribution box is the central hub of the home circuit and the general control of our daily power consumption. It is an indispensable electrical equipment. If there

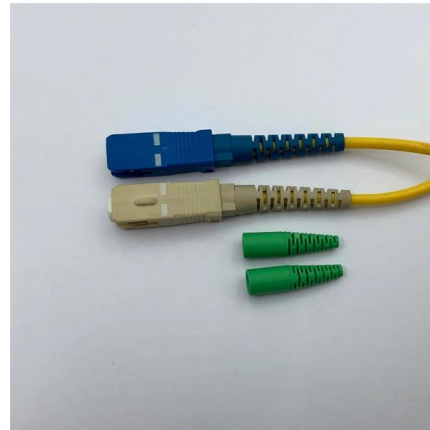

## See How Germans Connect Distribution Boxes

Witness the precise and professional wiring techniques of German experts as they connect distribution boxes.

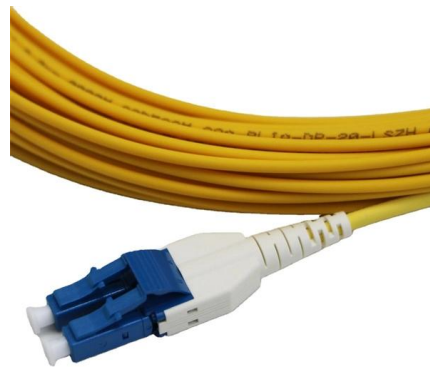

## See How Germans Connect Distribution Boxes

Witness the precise and professional wiring techniques of German experts as they connect distribution boxes. Learn about their meticulous process,



## How to Install a Cable Distribution Box Safely and

This article provides a detailed overview of the entire process of installing a distribution box, from pre-installation preparation to post-installation



## Enclosures and distribution boards

ENCLOSURES AND DISTRIBUTION BOARDS The product range of enclosures and distribution boards includes service entrance boxes and pillars, small

## Indoor / Outdoor Distribution Boxes , SENTAL Export

If you lay cables, these must also be distributed. We offer a wide range of street cabinets, as well as indoor and outdoor distribution boxes.

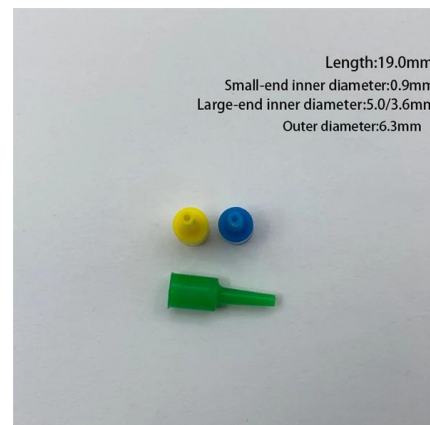



**MPO-MPO** Low Smoke Halogen Free Sheath  
Multimode 10 Gigabit 24 pole OM3  
Insertion loss <0.35dB Return loss >50dB

## Compact PD and multi-PD distribution boxes , Pluggable installation

Compact PD and Multi-PD distribution box  
Connection via prefabricated 2.5 mm<sup>2</sup> core cable  
Suitable for mounting in suspended ceilings and underfloor areas  
Suitable M20 cable gland for a 3×1.5 mm<sup>2</sup> or

## Temporary Power Distribution Boxes for Electrical

Temporary power distribution boxes for flexible electrical installation. Robust solutions for construction sites, events and temporary energy infrastructure.



Length:52.0mm  
Small-end inner diameter:3.0mm  
Large-end inner diameter:4.8mm  
Outer diameter:6.5mm

## Sicherungskasten

Various versions of distribution boxes, a large selection of materials, voltage ranges, rated currents and IP protection types / protection classes for indoor and outdoor use, as well as a wide range of

## Distribution box

The installation, expansion or modernization of a distribution box is subject to clear legal regulations in Germany. The regulations of the VDE (Verband der Elektrotechnik Elektronik Informationstechnik e.



## Electrical installation

With our Hanse series we offer simple possibilities for junction boxes and cable junction boxes, especially in the surface-mounted sector. With the help of the

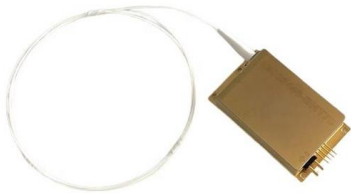

## Pluggable installation from KAISER.

The distribution boxes of the compact multi-PD series can be mechanically connected to each other. This easy to lock system means that several housings can be lined up next to each other so that



## How ASUS DSL-AC55U modem and Distribution box should be

TAE box and Rj45 distribution box (telegärtner mpd cat 6a) Hello, Next week, there will be a DSL activation for my apartment without a technician. This is going to be my first German DSL





## International-electrical-standards-regulations

SOLUFLEX FLOOR SYSTEM AND LCS2 ZONE DISTRIBUTION BOXES In the Soluflex cable floor system, all power cables, data and telecommunication are conveniently organized, completely out of

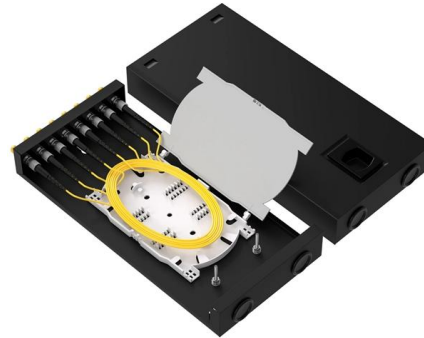

## Distribution box

In this article, you will learn everything you need to know about installing, expanding or replacing a distribution box - from the legal basis to practical implementation.

## General electrical installation requirements. By SCHELL.

SCHELL fittings are designed and manufactured according to the technical norms and regulations valid in Germany and - where generally available - in Europe and at an international level.

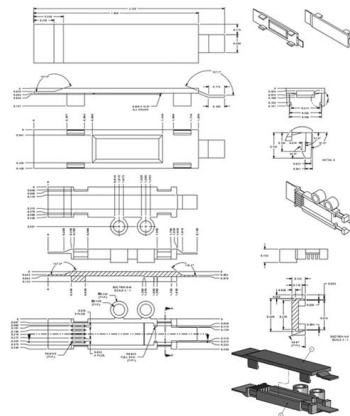

## Requirements And Specifications For Installation Of

In flammable and explosive environments, explosion-proof distribution boxes should be selected and explosion-proof treatment should be carried out.



## How to Install a Distribution Box--A Comprehensive

Distribution Box Installation: Put the distribution box on the installation surface, and align the position of the expansion bolts and tighten the screws. This

Mesh door/glass door optional



Sp-601 glass door



Sp-602 mesh door

## Contact Us

---

For datasheets, pricing, or custom telecom energy solutions, please visit:  
<https://koskolong.co.za>