



**Adam Tas Corridor Energy**

# **Installing distribution boxes near Taiwan**





## Installing distribution boxes near Taiwan

---



### List of Distribution Companies in Taiwan

We are professional tele-com parts manufacturer from Taiwan, and we make the following products, please contact for details:\*\* Optical Fiber Patch Panels, Frames\*\* Rack Mount / Wall Termination

### Taiwan Distribution Boxes Market Analysis: Size, Share & Trends

The Taiwan distribution boxes market is segmented into plastic and metal distribution boxes, catering to various applications including residential, commercial, and industrial sectors.

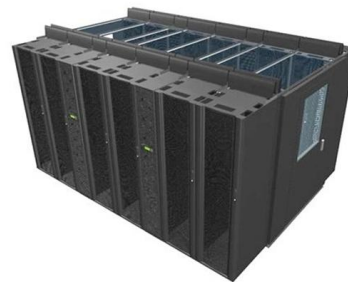

### How to assemble and install a household distribution box

How to assemble and install a household distribution box#distributionbox##electrician#electrical##electricalengineering

### Product - Zeifue

Zeifue produces all kinds of high and low voltage substations, high voltage distribution panels, low voltage distribution panels,



distribution panels, MCC motor control centers, center cabinets, power

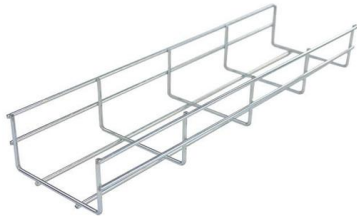
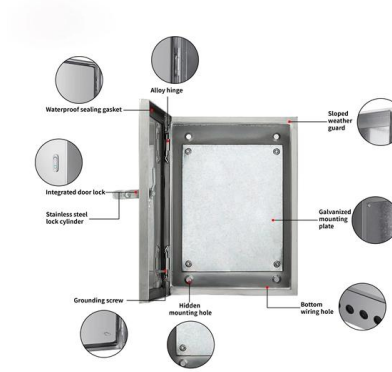

### Understanding Distribution Boxes: A Comprehensive Guide

These boxes come in a variety of sizes and shapes depending on how complex a system is and the electric requirements of the building. A variety

### Distribution boxes, telecommunications, plastic Companies in Taiwan

Chemicals, Pharmaceuticals & Plastics / Plastic products / Plastic boxes and enclosures, for the electrical and electronics industries / Distribution boxes, telecommunications, plastic



### distribution box, Taiwan distribution box Manufacturers and

TSM distribution boxes/ distribution boards are suitable for distribution control of modern buildings, such as large stores, guesthouse,



## Decentralized Building Automation Distribution Boxes

Distribution boxes for building automation. Pluggable system solutions for energy-efficient smart buildings with flexible and fast electrical installation.

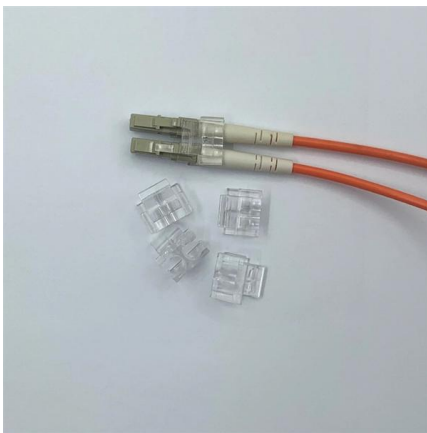

## Taiwan Distribution Boxes Market Analysis: Size, Share & Trends

The "Taiwan Distribution Boxes Market" prioritizes cost control and efficiency enhancement. Additionally, the reports cover both the demand and supply sides of the market.

## Electrical Distribution Box|OC Outdoor Cabinets|Ea

EAHWA offers high quality custom enclosures and modification services for your unique requirements. Electrical distribution box ensures equipment work



## Installation requirements for distribution boxes

Distribution boxes shall be made of non-combustible materials; open distribution boards may be installed in production places and offices with low electric shock risk; enclosed cabinets shall

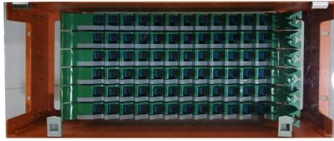

## 113 years of equipment installation projects such as high-voltage

Whether you're targeting the Infrastructure and construction sector in Taiwan, or expanding across regions, we provide live, accurate, and relevant updates every day.

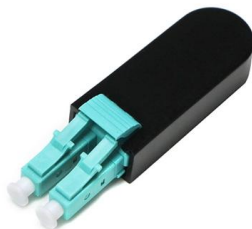
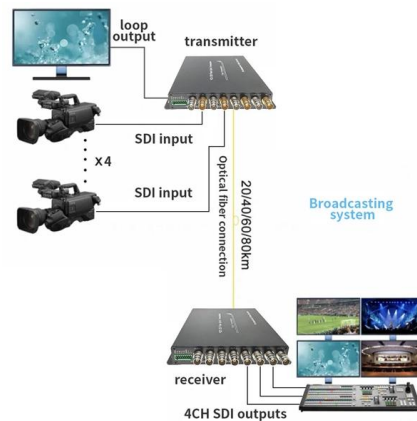

## Understanding Distribution Boxes: A Comprehensive Guide

A distribution box, also known as a power distribution box or electrical distribution box, is used to distribute electrical power safely to multiple

## What to Look for in a Taiwan Warehouse for Distribution Across Asia

Discover your ideal Taiwan warehouse and 3PL partner for efficient distribution across Asia. Expertise and facilities customized for you.





CORE  
Long transmission distance



JACKET



STEEL  
High strength



## How to Install a Distribution Board: A Complete Guide

In this video, we'll walk you through the step-by-step process of installing a distribution board (also known as a breaker panel) safely and efficiently. Whe

## The Installation Process of Distribution Boxes

Let's take a look at how distribution boxes are installed, ensuring electrical safety. Have you ever fixed any small repairs around the house? If you're into



## How to Choose a House Distribution Box , CHINT global

A well-chosen distribution box ensures the safety and efficiency of your household electrical system. This article guides you through selecting a

## Small distribution box installation steps

The steps to install a small distribution box include selecting a suitable location, installing the base, placing the distribution box, connecting the



## Start your distribution business in Taiwan

Launch your distribution business in Taiwan with professional guidance on legal, financial, and operational matters.



## Cautions and Requirements for Installation of

8. After installation, the residue in the distribution box should be cleaned up. When the distribution box is installed and constructed, some safety operation items



## Distribution box

Distribution box Distribution cabinet XL<sup>3</sup> 125 - 3 rows - 54 modules - surface mounting Add to Quote 401677

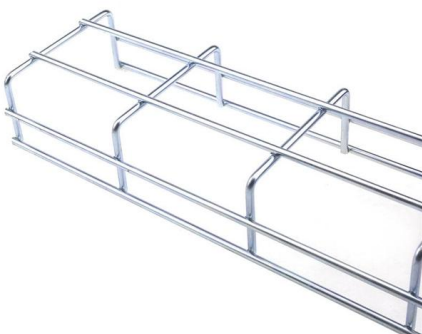



## Taiwan

Commercial Service: International Company Profile (ICP) Service The most common distribution route in Taiwan moves products from suppliers to distributors, from distributors to



### Summary of key points for construction and installation of distribution

The construction and installation points of distribution boxes and switch boxes are summarized as follows: 1. Select qualified products that meet national standards and safety requirements.

### Distribution Box Installation: Advanced Techniques

Distribution Box Installation: Advanced Techniques. The installation of a distribution box is explored in detail, highlighting advanced techniques for achieving a professional and efficient setup.

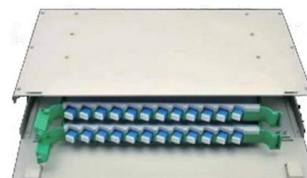

### News

The installation of power distribution cabinets and boxes in data rooms is crucial for ensuring efficient and reliable power distribution. However, this process requires careful attention to detail to guarantee



### Key Points Of Distribution Box Installation

3. Distribution box and switch box shall be installed in ventilated, dry and normal temperature places. It is strictly prohibited to install it in the gas, flue gas, steam, liquid and other harmful media with severe



### Key Points Of Installation And Collocation Of Distribution Box In

7. The wire inlets and outlets in the distribution box and switch box shall be set at the lower bottom of the box. It is strictly prohibited to set them at the top, side, back or door of the box. The inlets and outlets

## Contact Us

---

For datasheets, pricing, or custom telecom energy solutions, please visit:  
<https://koskolong.co.za>