



Adam Tas Corridor Energy

Intelligent distribution box control switch





Intelligent distribution box control switch



Intelligent Low-Voltage Distribution Boxes

Intelligent low - voltage distribution boxes are essential for power distribution. They're used in residential areas to supply stable power to homes. In commercial

Intelligent Distribution Network Solutions

It has supplied more than 300,000 sets of various medium-voltage switches and ring main units and more than 200 sets of systems covering 60% cities in China to meet the application requirements



Smart switchgear , Solutions , ABB

Consultants/EPCs Designing and implementing intelligent distribution can be a demanding task. ABB offers pre-designed, flexible and Standard compliant

Design and Construction of a 60a Smart Distribution Board with Real

This work aims to address these issues by designing and constructing a 60A smart



distribution board. This smart distribution board will incorporate intelligent features such as real-time monitoring, load



Advanced Stainless Steel PLC Control Distribution Box for Smart

Advanced Stainless Steel PLC Control Distribution Box for Smart Systems, Find Details and Price about Customized Electrical Box Intelligent Distribution Box from Advanced Stainless Steel PLC Control

Intelligent Remote Distribution Box Monitoring Solution

Remote distribution box monitoring By leveraging the intelligent remote monitoring function, you can collect the electric meter readings and implement networked

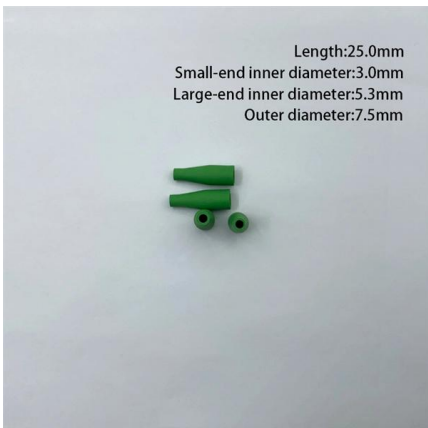

Building a Smart Distribution Panel: The Ultimate DIY Project

Conclusion Building your own smart distribution panel is a rewarding and empowering DIY project that unlocks a world of possibilities for intelligent power management.



Final Power Distribution Boxes , Product Catalog , CHINT Global

Compact final distribution boxes for safe, accessible, and precise power control across all electrical environments.

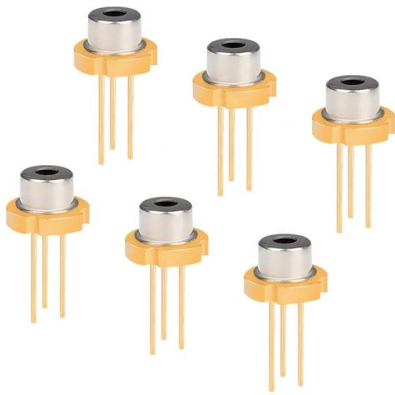
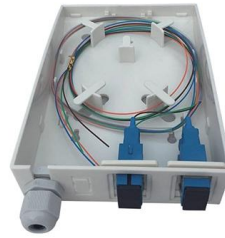

Distribution Automation , Siemens

Ensure reliable energy supply with Siemens distribution automation. Boost grid performance and availability - learn more now.

Intelligent Power Distribution Box Solution

Intelligent power distribution box is composed of traditional leakage protector, air switch, AC contactor and KC868-H8.



XGN66-12 Switch Cabinet Intelligent Control Power

XGN66-12 fixed closed switchgear (hereinafter referred to as switchgear) is our company's new generation of high-voltage electrical complete sets of products, in

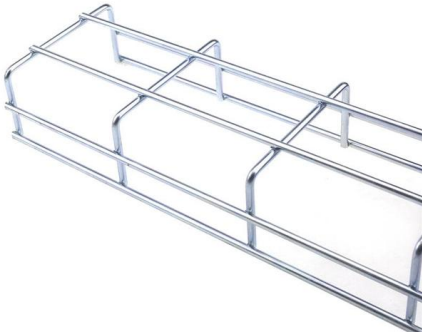

Construction of intelligent power distribution system in

Abstract and Figures Based on the field-bus technology and combined with the industrial control products, the intelligent power distribution system in box



120V Intelligent Power Distribution Box , HAO-AIXI

The 120V intelligent power distribution box is a secondary power distribution device for the 120V DC power system. It is used for the power distribution management



Distribution Automation , Siemens

Our distribution automation solutions optimize primary equipment O& M, boost supply safety & voltage quality, and adapt quickly to network changes. They also feature





Intelligent Distribution Box

The intelligent distribution box, developed with IoT tech, allows checking, setting, and adjusting of electrical parameters. It monitors real - time circuit data like current, voltage, and detects faults.

Electrical AC/DC Power Distribution Box & Cabinet for Industry

It has the functions of monitoring the low-voltage side load and frequency of the distribution transformer, collecting power, and controlling the switching of capacitors.

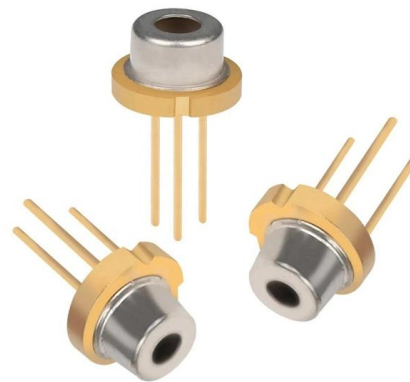

Main functions and application fields of intelligent distribution box

In the future, the intelligent switch in the intelligent distribution box is suitable for low-voltage distribution system, which is easy to operate, stable in performance and flexible in assembly.

WO2024255014A1

The intelligent distribution box comprises multiple electrical devices, the electrical devices at least comprising a common power supply module, a main input intelligent circuit breaker, at least one



Main functions and application fields of intelligent distribution box

9. Remote control, mobile phones, tablets, laptops and other terminal equipment can be used for remote monitoring of various power lines. Application field of intelligent distribution box Its applicable places



Bivocom IoT Electrical Panel: Smart Power Distribution

Discover Bivocom IoT electrical panel solutions for smart power distribution, real-time monitoring, and predictive maintenance. Transform



Intelligent Distribution , Solutions , ABB

Solutions for smart low voltage electrical distribution Digital technologies such as Cloud Computing, Big Data, Internet of Things (IoT), Artificial Intelligence (AI) and



SMC 3800V 100-1000A Fiberglass Low-Voltage

The low-voltage cable distribution box is applicable to the low-voltage power distribution system with AC 50Hz and rated voltage of 220/380v in industrial and



Linear actuator control boxes

Control boxes LINAK® linear control boxes are designed to deliver reliable and precise performance for electric actuator systems across various industries. Built

ABB i-bus KNX

Highlights Heating, Ventilation and Air Conditioning ABB i-bus® KNX intelligent building control integrates the heating, air-conditioning and ventilation



Smart Three-Phase Electrical Panel Based on IoT Integration and

It underscores the integration of intelligent control components into a conventional power distribution network, offering a complete and visually accessible depiction of the three-phase electrical

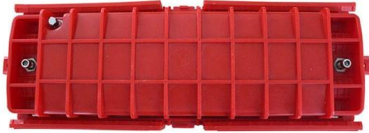

EL2P Intelligent Power Distribution Unit

The EL2P PDU provides reliable, intelligent power distribution in hospitals and clinics, reducing install complexity and enhancing uptime for medical networks

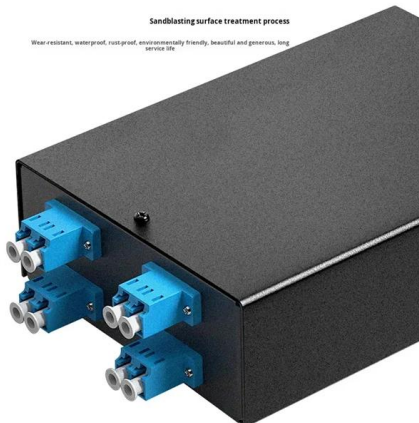

Design of Intelligent Distribution Control System Based on BP Neural

Intelligent power distribution system is based on the needs of users and in accordance with the standard specifications of the power distribution system under the premise of secondary development of a set

EL2P Intelligent Power Distribution Unit

Managing and installing a rack power distribution unit (PDU) has never been easier than with the EL2P PDU. Designed to simplify deployment and take stress out of





Research on Key Technologies of Intelligent Control Switches in

Considering the different dispersion of the intelligent control switch, the process of closing the parallel capacitor is simulated, and the effect of the intelligent control switch on the

Contact Us

For datasheets, pricing, or custom telecom energy solutions, please visit:
<https://koskolong.co.za>