

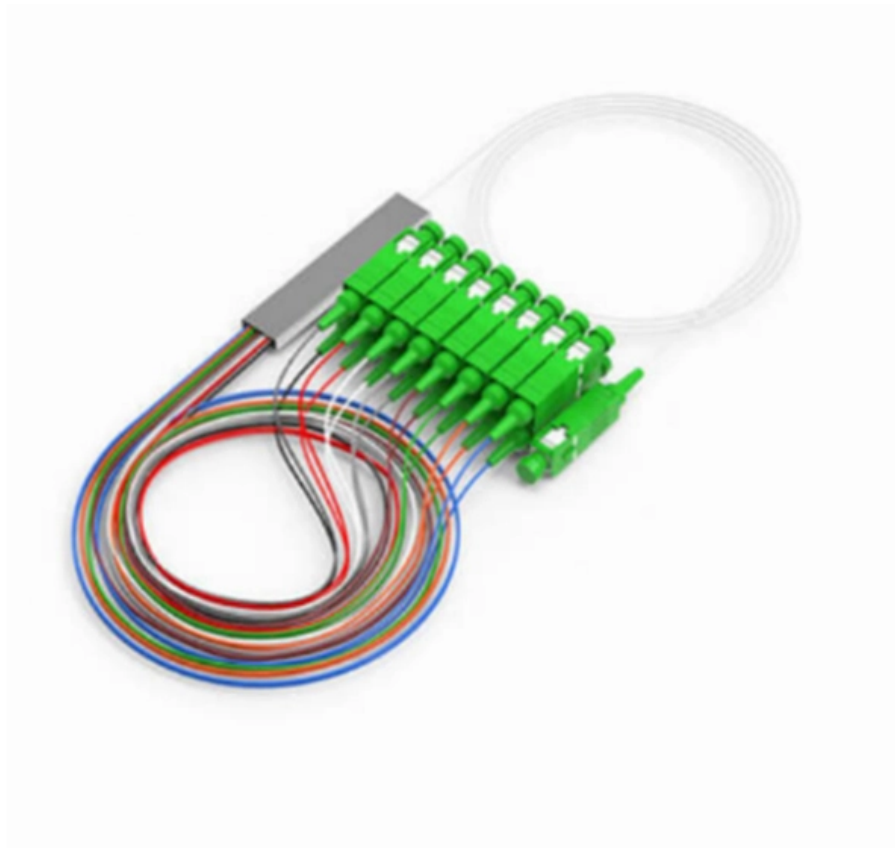

Adam Tas Corridor Energy

Ireland CIF price for single-mode drop fiber optic cable





Ireland CIF price for single-mode drop fiber optic cable



Fiber Optic Cable Bulk 1 Core Aerial Drop FTTX Fiber

Fiber Optic Cable Bulk 1 Core Aerial Drop FTTX
Blue Fiber 2km G.652.D Single Mode Model #
4293 Fiber Optic Cable Bulk - 1 Core Aerial Drop
Fiber FTTX

Wholesale fiber optic cable price and 4 way to save cost

In general, fiber optic cable price can vary from \$0.3 to \$5 per meter (\$0.09 to \$1.52 per foot). For example, a typical FTTH drop cable of 1 core is

Pre-Terminated Patch Panel

- Multi-application support
- Flexible configuration
- Modular design

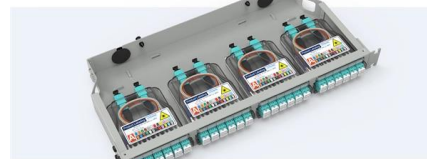

Cable Gland Plug
28mm Cable Gland Plug



MPO LC up to 96 cores
MPO direct connection 48 ports



Mounting Bracket
Semi-open mounting holes

2 Fiber Tenable Flat Drop Cable

Our Fibertronics, Inc. tenable flat drop cable offers an amiable solution for fiber to the home or fiber to the premises applications.



005-924-010-01B CONNECTIX CABLING SYSTEMS, Fibre Optic Cable

Buy 005-924-010-01B - CONNECTIX CABLING



SYSTEMS - Fibre Optic Cable, Singlemode, 125 μ m. Farnell® Ireland offers fast quotes, same day dispatch, fast delivery, wide inventory, datasheets &



Fiber Optic Cable , Farnell® Ireland

Ideal for telecommunications, data centres and networking applications, our fibre optic cables are available in single-mode and multimode configurations to meet the specific needs of your system.

Cost of Fiber Optic Cable: Pricing Guide (2026)

Discover the cost of fiber optic cable in this pricing guide. Learn material prices, installation factors, and what impacts total project costs overall.



How Much Does Fiber Optic Cable Cost?

Understand the cost of fiber optic cable, factors that impact cost, and key considerations to help you get the most out of your budget. Contact Cables



G657A1/A2 Singlemode Butterfly Type Drop Fiber Optic Cable

Description FTTH drop cable with easy accessibility to the fiber and simple installation, FTTH cable can be directly connected to the homes. It is suitable for connecting with communication equipment, and



Fiber Optic Fibre Optic Cables - Mouser Ireland

Fiber Optic Fibre Optic Cables are available at Mouser Electronics. Mouser offers inventory, pricing, & datasheets for Fiber Optic Fibre Optic Cables.

Range of Fiber cables & patch cords from Satworld

1m Fibre Optic Patch Cord SC/UPC-SC/UPC SM
EUR3.00 EUR2.50 (EUR3.08 inc VAT) Save 10%
1m Fiber Optic Patch Cord LC/UPC-LC/UPC SM
Duplex EUR4.00 EUR3.60 (EUR4.43 inc VAT)
Save 10% 0.5m Fiber Optic

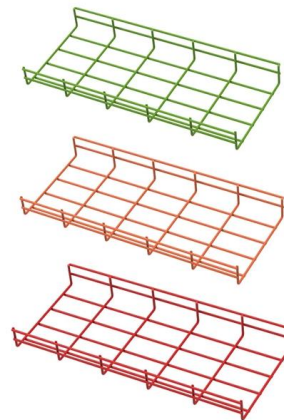

How Much Do Single-Mode Fiber Optic Cables Cost?

Explore the cost factors influencing single-mode fiber optic cables in 2025. Understand pricing variations based on specifications, applications, and



Fibre Optic Cables Ireland , Single & Multimode , Sa

Shop Fibre Optic Cables in Ireland including singlemode, multimode, SC, LC and ST patch leads for ultra-fast data networking and long-distance transmission. Ideal for modern home networks, offices,



Fiber Optic Project Estimator , Progressive Office Cabling

Fiber Optic Project Cost Estimator Typically, per drop fiber cabling prices range from \$250 - \$1000 per drop depending on the type of fiber (OM2, OM3, OM4, or

Drop Cable Pricing: Comprehensive Guide to Cost-Effective Network

Explore competitive drop cable pricing options, featuring flexible models, quality assurance, and value-added features for optimal network infrastructure investment. Learn about cost-effective solutions for

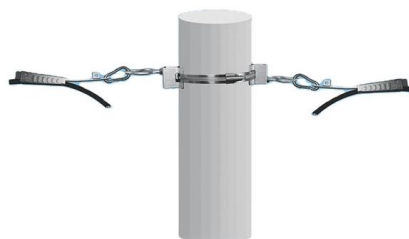

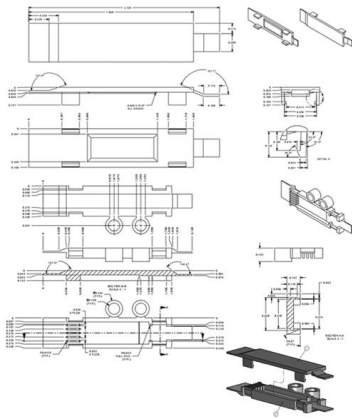

Fibre Optic Cable , Fibre Optic , RS

Single-Mode Fibre (SMF): Single-mode fibre is used for long-distance, high-bandwidth applications. It has a smaller core and transmits data using a single mode of light, resulting in less signal dispersion

Fibre Optic Cable , Cable & Cable Management , Screwfix

Labgear Duplex Multi Mode Green/Yellow LC- LC OM3 LSZH Fibre Optic Cable 5m (245KM) compare Green/Yellow LSZH PVC Cable Max. 100Gbps Ethernet Speed OM3 for Broad Network Application

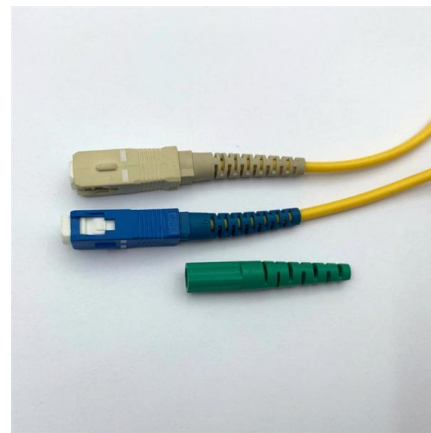

Fiber Optic Cable Cost Per Foot: Price Range 2026

The main cost drivers include cable type (single-mode vs multimode), whether the run is indoors or outdoors, trenching or direct burial requirements, and labor time. The following sections

Fiber Optic Cable , Farnell® Ireland

Farnell's fibre optic cables are engineered to provide high-speed, high-bandwidth data transmission over long distances with minimal signal loss. Ideal for telecommunications, data centres and networking

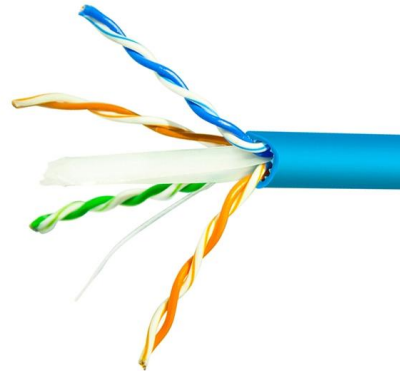

Pre-terms

Wood Communications stockists of Fibre Optic Cable & Networking in Ireland. Explore our Pre-terms in stock. Get a quote now.



Fiber Optic Cable Installation Cost Guide 2026

Buying fiber optic installation services involves several cost components, with total price influenced by length, location, and access. The main cost drivers include trenching or aerial

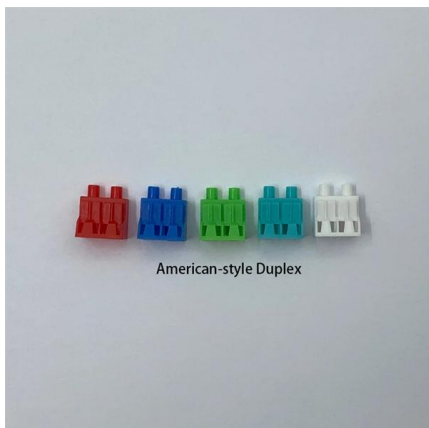

Fiber Optic Cable Pricing Guide: Factors That Affect

Fiber optic cables are essential components in today's broadband, FTTx, and data center networks. Whether you're planning a national fiber rollout



Flat Drops

Drop Cable, Singlemode, 6 ct., Single Mode, No Armor, Toneable Flat Drop, Zero Water Peak, Price Per Ft., Our reels have a manufacturing variance up to 5%,



Singlemode Optical Patch Cables

Best Prices and FAST DELIVERY on Singlemode Optical Patch Cables in Ireland.

FTTH Drop Flat Fiber Optic Singlemode Cable , Fiber

FTTH drop flat Fiber optic single mode cable with FRP. It is mostly Installed in riser ducts and cable trunks. It can also be made into a 2 to 12 cores

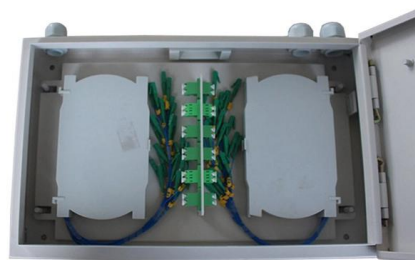

Fiber Optic Cable , Farnell Ireland

Farnell's fibre optic cables are engineered to provide high-speed, high-bandwidth data transmission over long distances with minimal signal loss. Ideal for telecommunications, data centres and networking

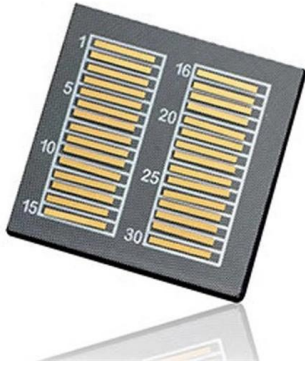

FIS Flat Drop / Drop Cable and Cable Spool Bulk Pricing

FIS Flat Drop / Drop Cable / Cable Assemblies and Cable Spool Bulk Pricing Your Source For Everything FTTx Email a FIS FTTx Representative with any

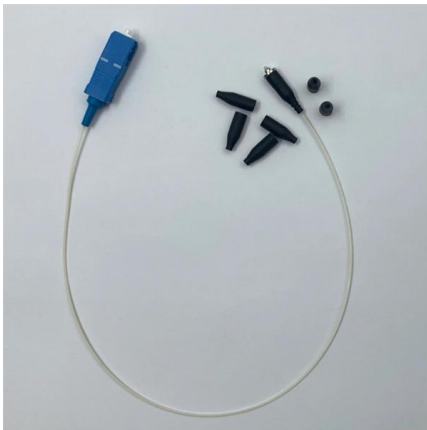

Single-Mode Fiber Optic Cable Costs: Pricing Insights

Explore the cost factors influencing single-mode fiber optic cables in 2025. Understand pricing variations based on specifications, applications, and

Singlemode Fibre Optic Cables - Mouser Ireland

Singlemode Fibre Optic Cables are available at Mouser Electronics. Mouser offers inventory, pricing, & datasheets for Singlemode Fibre Optic Cables.





Fibre Optic Cables - Mouser Ireland

Mouser offers inventory, pricing, & datasheets for Fibre Optic Cables.



FTTH Drop Cable , Indoor & Outdoor Fiber Optic Drop

Secure your network's last mile with our professional-grade FTTH Drop Cables. Featuring a flat, easy-strip design and G.657 bend-insensitive fiber, these cables



Contact Us

For datasheets, pricing, or custom telecom energy solutions, please visit:
<https://koskolong.co.za>