



Adam Tas Corridor Energy

Is a 2-meter Huijue fiber optic patch cord sufficient





Overview

For a typical office or datacenter, standard-length patch cords in the range of 2m to 10m are often all that is needed. A patch cord is an essential component of a fiber optic setup, being cost-efficient while being compatible with most devices and easy to find in stores. This is why a common length like the 2m LC LC patch cord, a 3m or even 5m patch cord is widely used, for instance, they strike a balance between flexibility and performance. The wrong choice — whether it's an underperforming multimode grade or an unnecessarily expensive singlemode run — can either cripple your network's reliability or. Fiber patch cords—commonly referred to as fiber jumpers, fiber patch cables, or fiber patch leads—are short-length optical cables terminated with fiber optic connectors on both ends.



Is a 2-meter Huijue fiber optic patch cord sufficient



How to Choose Fiber Optic Patch Cord?

Discover the essential guide on choosing the perfect fiber optic patch cord for your needs. Learn about crucial factors such as connector types, fiber

Choosing the Right Optical Fiber Patch Cord

Find out how to select the perfect optical fiber patch cord for your needs. Explore considerations, maintenance tips, and troubleshooting techniques for optimal performance.



ZIFONIC, Fiber Optic Patch Cord Procurement Guide

ZIFONIC's guide to choosing fiber optic patch cords for data centers, telecom, and FTTH. Ensure high performance and reliability.



A Comprehensive Guide to Fiber Optic Patch Cables

Fiber optic patch cables are found almost everywhere; cable television networks (CATV),



data centers, computer networks, and telephone networks. Fiber optic

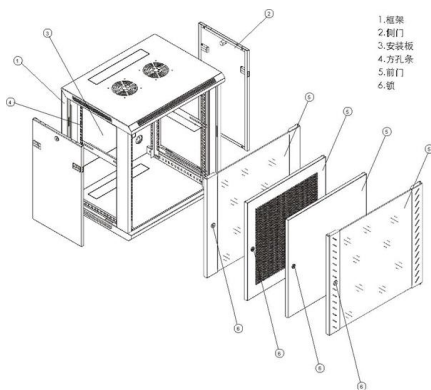

Fiber Patch Cable Selection Guide 2026: How to Choose the Right

Which fiber patch cable fits your network? Compare OS2, OM3 & OM4 specs, match fiber to distance and speed, avoid costly mistakes. Expert guide for data centers.

How to choose the right fiber patch cables?

Multifiber Fiber Patch Cables are essentially multiple standard fiber patch cords bundled together, making installation faster and easier. These are



What Are Fiber Patch Cord Types and How to Select

Fiber patch cord is also called fiber patch cable, fiber jumper, or fiber patch lead. The common fiber optical patch cords can be classified into different





Understanding Patch Cables: A Comprehensive Guide

2. Fiber Optic Patch Cables Fiber optic patch cables are used for high-speed, long-distance data transmission. They transmit data as light pulses, making them immune to

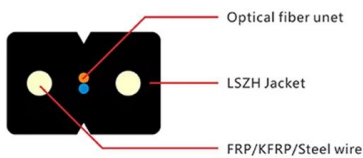

Custom 5-meter 2.0mm Lszh Om3 Duplex Lc/upc Fiber Patch Cord

The LC/UPC-LC/UPC-OM3-DX-2.0-5M is a duplex multimode fiber patch cord designed for high-speed data centers and enterprise networks. Featuring OM3 multimode fiber and LC/UPC connectors, with

Best Practices for Fiber Optic Patch Cable Lengths

Selecting the appropriate cable length for fiber optic patch cables is crucial for maintaining optimal network performance. Incorrect cable lengths can



Fiber Optic Patch Cords: Specifications , RLH Industries,

Our fiber optic patch cords are factory terminated, inspected and tested to meet industry standards. They are available in either riser or plenum flame rating, and



What are the standard lengths of fiber patch cables?

2 Meters (6.56 Feet): A slightly longer option, suitable for connections that require a little more reach than the 1-meter cables. This length is ideal for connecting



What are Fiber Patch Cables?

Here's All You Should Know Fiber patch cord is seeing broad adoption in applications spanning telecommunication and data communication. With numerous business and enterprise reaping great

Understanding Fiber Patch Cord Types

Whether you are setting up an LC to LC patch cord connection for a small office or integrating an LC to LC multimode fiber patch cord in a large-scale network, this article will give you the insights you need.



2 Core Single Mode Armored Optic Fiber Patch Cord

The armored patch cord is engineered for environments where a standard patch cord would be prone to damage. Our 2-core single-mode



Fiber Optic patch cords

Singlemode fiber optic patch cords come with a 9 micron diameter glass core. With the cladding layer, they are 125 micron, and with the buffer layer they are 250

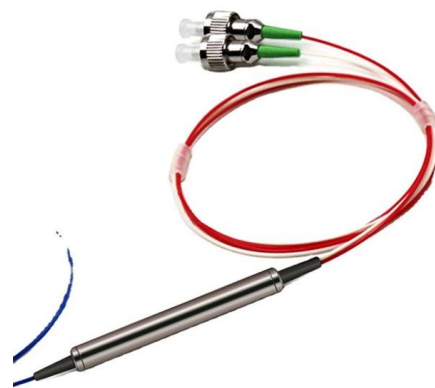

what are the international standards for fiber optic patch cord

Relevant for Ethernet applications, this standard specifies that the length of fiber optic patch cords should range from 2 to 10 meters, depending on the network topology and operational speed?1?

Fiber Optic Patch Cord, Fiber Optic Patch Cord Types , JUNPU

Fiber optic patch cords come in various standard lengths, such as 1 meter, 2 meters, and longer. Choosing the right cable length is essential to ensure that the patch cord reaches from one network

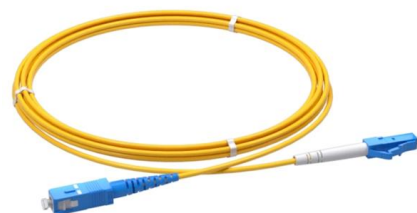

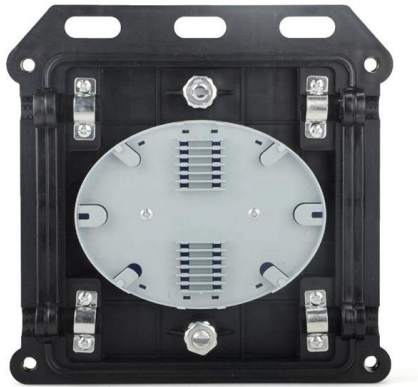

Fiber Optic Cable Types Explained: Choosing the Right

Fiber Optic Patch Cable Types and How to Choose the Right One? Fiber optic cables come in various types based on different specifications and

Fiber Patch Cords: Types and How to Choose the Right

As networks evolve to support 5G, AI, and cloud computing, selecting the right fiber patch cord has become more important than ever--one wrong choice can lead to



Product Catalog



Ultimate Guide to Fiber-Optic Patch Cables: Types, Selection, and

Fiber optic patch cables connect servers, switches, and storage systems with speed and precision. These cables reduce latency time and can handle heavy data loads without error.

11 Things You Need to Know About Fiber Patch Cable

A fiber optic patch cable, cord, or optical jumper has fiber optic connectors (LC, SC, MTRJ, ST, FC, MU, and more) at either end. These



Telecom Cabinet Manufacturer, fiber optical patch cord, 12 core patch

Telecom Cabinet Supplier, fiber optical patch cord, 12 core patch cords Manufacturers/ Suppliers - Shanghai Huijue Network Communication Equipment Co., Ltd.



What Are Fiber Patch Cord Types and How to Select Fiber Patch Cords

Fiber patch cord is also called fiber patch cable, fiber jumper, or fiber patch lead. The common fiber optical patch cords can be classified into different fiber jumper types based on various

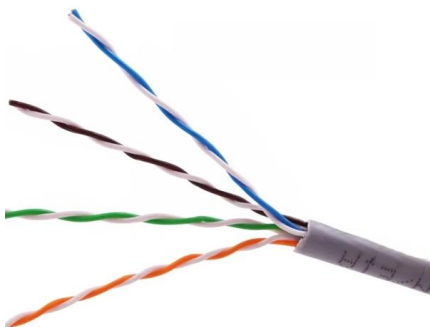
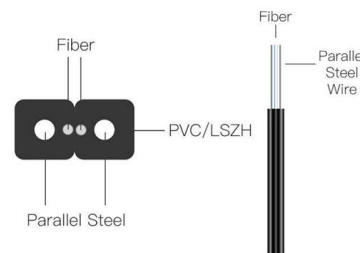

Fiber Optic Patch Cords: A Complete Guide to Types,

Fiber optic patch cords come in various types to suit different applications, At CloudTop Cable, Whether you need single-mode or multimode, simplex or duplex,



What Are Fiber Patch Cord Types and How to Choose?

Conclusion Fiber patch cord has helped many people to achieve larger bandwidths and greater speeds, and the benefit of which is stretching across a



Fiber Patch Cables - How to Choose High-Quality Ones

Are you struggling to find the right fiber patch cable for your project? Whether you're setting up a data center, upgrading your home network, or

The Comprehensive Guide to Fiber Optic Patch Cables

Discover how fiber optic patch cables are integral to the seamless operation of modern networks, offering significant advantages.



what are the international standards for fiber optic patch cord

This standard provides guidelines for telecommunications cabling systems, including specifications for fiber optic patch cords. It recommends that patch cords should generally not exceed 5 meters in



Fiber Optic patch cord FAQs

Fiber optic patch cords are a crucial component in high-capacity data centers, where they are used to interconnect various active and passive network equipment such

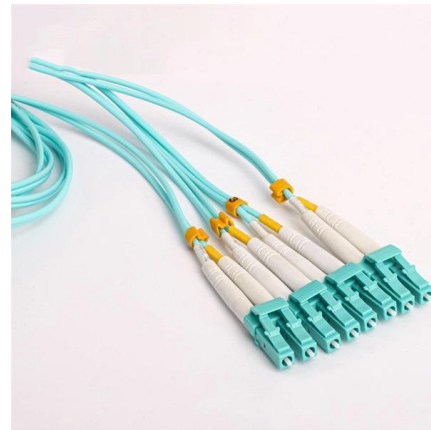

FIBER PATCH CABLES DATASHEET

Fiber optic patch cables are ideal for supporting high speed telecommunication network fiber applications. They are manufactured and tested in compliance with TIA 604 (FOCIS), IEC 61754 and

Fiber Optic Patch Cables: The Complete 2026 Buyer's Guide

Confused by LC, SC, MPO, UPC, and APC? This complete fiber optic patch cable guide covers connector types, single-mode vs multimode, insertion loss specs, and how to choose the right





Contact Us

For datasheets, pricing, or custom telecom energy solutions, please visit:
<https://koskolong.co.za>