

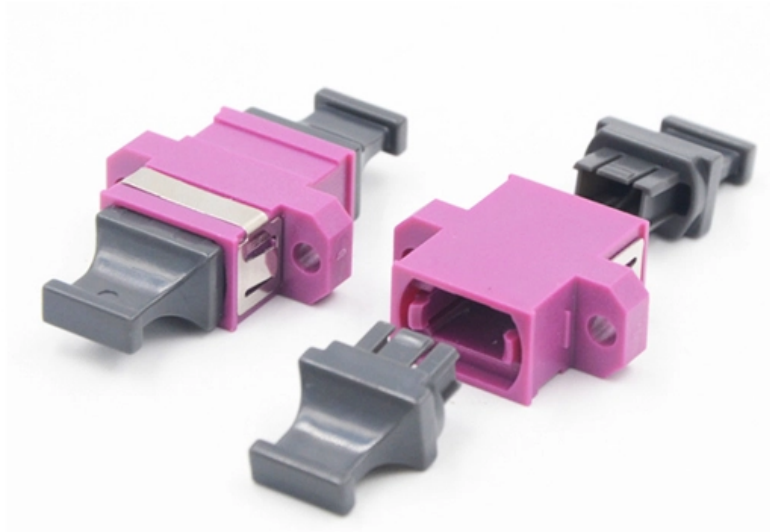

Adam Tas Corridor Energy

Lithuanian Outdoor Communication Power Supply Cabinet 200kW Solution





Lithuanian Outdoor Communication Power Supply Cabinet 200kW S



Communication Power Supply Cabinet 200kW Energy Management

Learn about Communication Power Supply Cabinet 200kW Energy Management - professional energy storage and power solutions including energy storage containers, photovoltaic containers, battery

200kW, 1200V, 250A DC-DC Cabinet

The unit is a bidirectional 200kW / 1200V DC/DC power converter cabinet solution. As a combined buck/boost air-cooled converter, it can be set up in either charging



200kwh Outdoor Integrated Energy Storage Cabinet

Discover TANFON's Outdoor Integrated Energy Storage Systema cutting-edge solution that seamlessly combines lithiumiron phosphate batteries. advanced

200kW Communication Power Supply Cabinet for Energy Storage

The large 200kW energy storage cabinet is a significant development in the field of energy



storage. With its high power capacity, it offers several advantages and applications.



200kW, 800V, 400A DC-DC Cabinet

The unit is a non-isolated bidirectional 200kW / 800V DC/DC power converter cabinet solution. Flexible design and application with its 800 Vdc maximum



How much is the Lithuanian outdoor communication battery cabinet

This 100KW 215KWH C& I BESS cabinet adopts an integrated design, integrating battery cells, BMS, PCS, fire protection system, power distribution system, thermal management system, and energy



Custom All in One Cabinet 100kw 200kw 241Kwh

Liquid-cooling outdoor cabinet features 50kw 100kw 200kw lithium battery configurations, tailored for solar energy storage. Liquid cooled 241kwh 261kwh





Telecom Outdoor Cabinets Battery Rack Enclosure Lipo Battery

Telecom Outdoor Cabinets Battery Rack Enclosure Lipo Battery 100Kw 200Kw 400Kw Home Use Rack Mount Home Energy Storage System :: Stafir Investing in your energy future starts today. Embrace



200kwh Outdoor Integrated Energy Storage Cabinet

200kwh Outdoor Integrated Energy Storage Cabinet TANFON's Outdoor Integrated Energy Storage Systema cutting-edge solution that seamlessly combines

200kW Communication Power Cabinet Distributor

The Base Station Energy Cabinet is a fully enclosed, weather-resistant telecom energy cabinet designed to provide reliable power distribution and battery backup for outdoor communication networks.

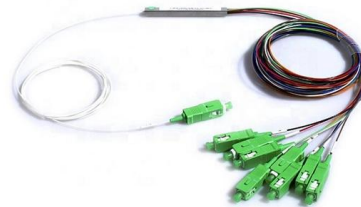

USA Communication Power Supply Cabinet 200kW Specifications

ICEENG CABINET serves customers in 18+ countries across Africa, providing outdoor communication cabinets, power equipment enclosures, and battery energy storage cabinets for telecommunications,



OUTDOOR COMMERCIAL MICROGRID LITHIUM BATTERY

Available in both 100kWh and 215kWh capacities, this modular system integrates power modules, batteries, cooling, fire protection, and environment monitoring in a compact outdoor cabinet.



200KWh Outdoor Cabinets

Our 200KWh outdoor cabinet energy storage system features a battery pack system enclosure with triple fire protection. With independent relay protection and battery-level thermal monitoring, you can

200kW Container Energy Storage Cabinet: Your Power Solution,

A storm knocks out your factory's power. While your competitors scramble, your production line hums along smoothly - thanks to a 200kW container energy storage cabinet quietly doing its job in the



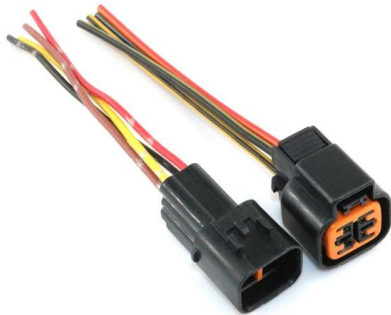

200kW Communication Power Supply Cabinet Under Warranty

The Base Station Energy Cabinet is a fully enclosed, weather-resistant telecom energy cabinet designed to provide reliable power distribution and battery backup for outdoor communication networks.

200kW modular outdoor cabinet for research stations

That's exactly what a 200kW cabinet energy storage power station delivers. Designed for medium-scale commercial and industrial applications, this system balances energy supply, reduces grid



200kW, 1200V, 250A DC-DC Cabinet

Standards CE compatible, CSA certified Device Description The unit is a bidirectional 200kW / 1200V DC/DC power converter cabinet solution. As a combined

How much is the Lithuanian outdoor communication battery cabinet

Outdoor Cabinet BESS CX-CI002 is an all-in-one 215kWh lithium battery storage cabinet system specifically developed for demand regulation, peak shaving, industrial and commercial energy



Oilfield Communication Power Supply Cabinet 200kW

ICEENG CABINET serves customers in 18+ countries across Africa, providing outdoor communication cabinets, power equipment enclosures, and battery energy storage cabinets for telecommunications,

200kW Communication Power Supply Cabinet for Communication

Outdoor Communication Energy Cabinet , Moblie, Hybird Power Experience the HJ-SG-D02 series from Huijue Group, a versatile outdoor communication energy cabinet designed for stable power supply in



Outdoor ODM BESS Energy Storage System , 50

Looking for an ODM BESS energy storage system? Our all-in-one outdoor cabinet (50-100kWh) features an IP55 design, LFP cells, and easy expansion for C& I



One Site One Cabinet Power Cabinet Solution

Huawei's One Site One Cabinet power cabinet solution uses a compact, high-density design to simplify site management, reduce energy use, and support sustainable

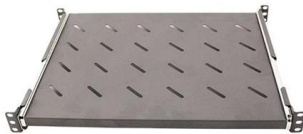

200KWH OUTDOOR CABINETS

Highjoule's Outdoor Photovoltaic Energy Cabinet and Base Station Energy Storage systems deliver reliable, weather-resistant solar power for telecom, remote sites, and microgrids. Our

Lithuanian outdoor energy storage cabinet export company

ICEENG CABINET serves customers in 18+ countries across Africa, providing outdoor communication cabinets, power equipment enclosures, and battery energy storage cabinets for telecommunications,



200kW South Korean Communication Power Supply Cabinet

Reliable 200kw power supply Solutions for Efficient Power Enhance energy efficiency with high-performance 200kw power supply. Designed for reliability and versatility, they offer optimal

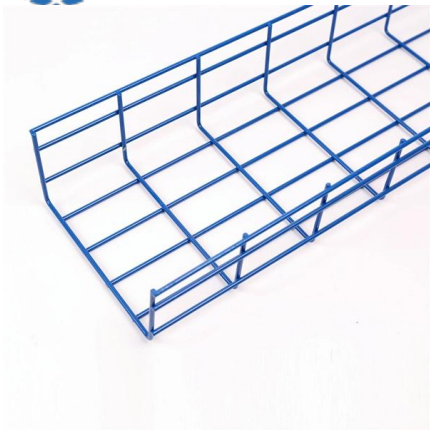

200KW CONTAINER ENERGY STORAGE CABINET YOUR POWER SOLUTION

African Technical Support Our certified specialists provide support for outdoor communication cabinets, power equipment enclosures, and battery storage cabinets across Africa.



Dawnice 200kWh Battery Storage Systems

The outdoor cabinet-type photovoltaic storage system, boasting a power rating of 100kW/200kWh, seamlessly amalgamates energy storage



200kW Communication Cabinet for Border Posts

Professional provider of modular cabinets, communication power systems, liquid-cooled energy storage cabinets, outdoor cabinets, UPS cabinets, and industrial storage solutions across Europe.





200KWh Outdoor Cabinets



200KWh Outdoor Cabinets energy storage system Our 200KWh outdoor cabinet energy storage system works with PowerNet outdoor control inverter cabinets for modular expansion. This means you can

HIGH EFFICIENCY 200KW BATTERY STORAGE SOLUTION

How does local system integrator supply the energy storage solution? Local system integrator will supply the energy storage solution, using battery units from CATL, power conversion systems (PCS) from

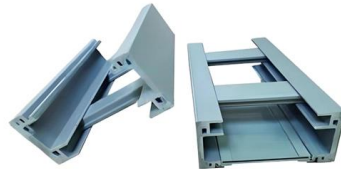

200kW Communication Power Supply Cabinet for Highways

The Base Station Energy Cabinet is a fully enclosed, weather-resistant telecom energy cabinet designed to provide reliable power distribution and battery backup for outdoor

200kW Communication Power Supply Rack for Distributed Energy

The outdoor cabinet-type photovoltaic storage system, boasting a power rating of 100kW/200kWh, seamlessly amalgamates energy storage batteries, PCS, power distribution,

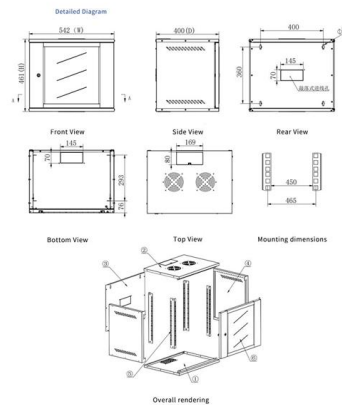

How much is the Lithuanian outdoor communication battery cabinet

These cabinets not only provide essential physical protection for various communication devices but also support continuous power supply through intelligent power management systems, laying a solid

Contact Us

For datasheets, pricing, or custom telecom energy solutions, please visit:
<https://koskolong.co.za>