

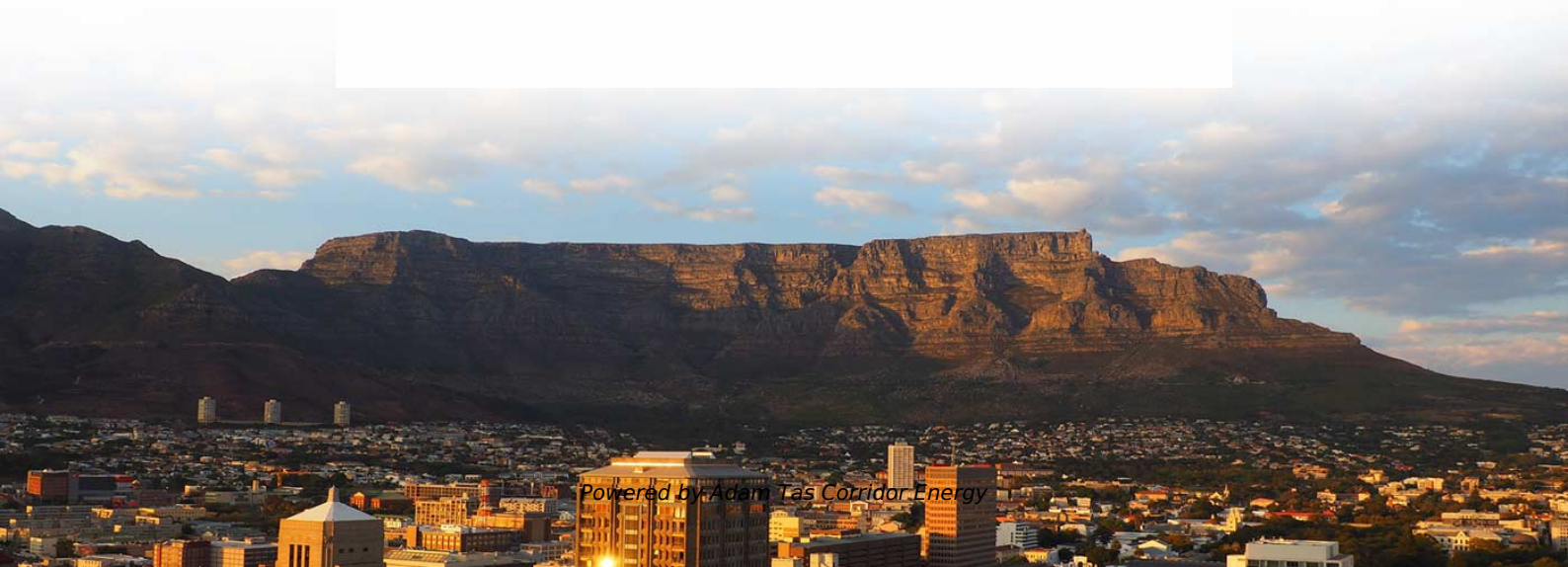

Adam Tas Corridor Energy

Manufacturer of Western European Standard Fiber Optic Connectors

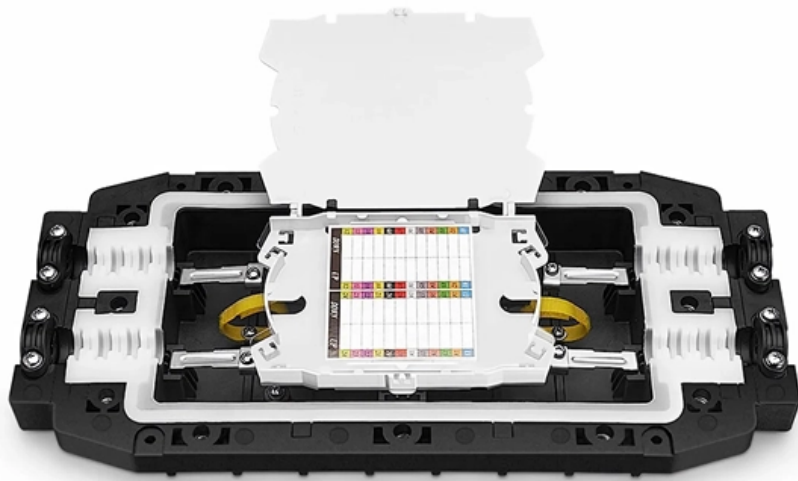



Overview

Amphenol Precision Optics GmbH, located in Sinn, Germany, is a leading European developer and manufacturer of high-precision interconnect technology for fiber optic systems. Since its founding in 1972, the company has specialized in precision mechanical components and has earned a reputation for. From initial consultation to delivery - we support you with expertise and customized components. This comprehensive analysis examines the top 10 European fiber optic cable manufacturers, their market positioning, technological innovations, and strategic advantages that have made them industry leaders. TTI offers inventory, pricing, & datasheets for Fiber Optic Connectors components from major suppliers.



Manufacturer of Western European Standard Fiber Optic Connectors



Fibre Optic Connectors

LEMO specialises in designing and manufacturing high-performance fibre optic connectors that ensure flawless signal integrity and data transmission in the most demanding environments.

Fiber optic Manufacturer/producer Germany

402 suppliers for fiber-optic Manufacturer/Producer Find wholesalers and contact them directly B2B marketplace Find companies now!

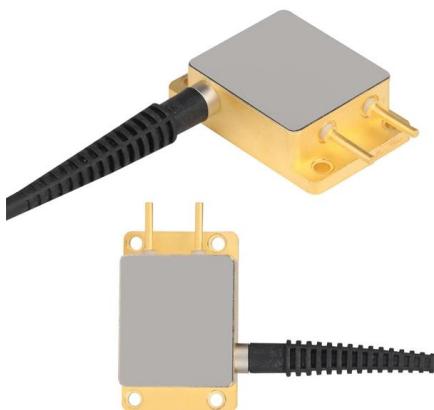
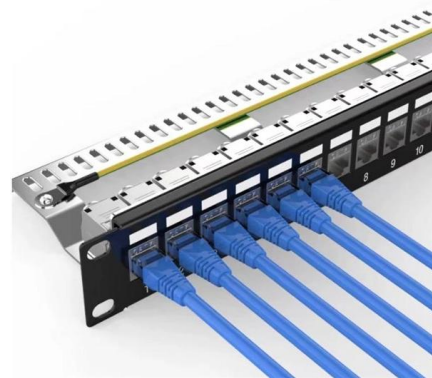

10 Best Fiber Optic Manufacturers for 2026

Discover the best fiber optic manufacturers globally, offering cutting-edge multimode and single mode fiber solutions. See who tops the list for quality

Top 24 Fiber Optic Cable Manufacturing Companies

Explore fiber optic cable manufacturing companies like AFL and WEC, emphasizing innovation and quality in telecommunications



Wiley Online Library , Scientific research articles, journals, books

Hier sollte eine Beschreibung angezeigt werden, diese Seite lässt dies jedoch nicht zu.



Fiber Optic Cable Hardware Accessories for Europe , Weunion

Fiber optic cable hardware accessories -- clamps, tensioners, dampers, banding systems, pole brackets -- are the unglamorous but mission-critical components that determine whether aerial

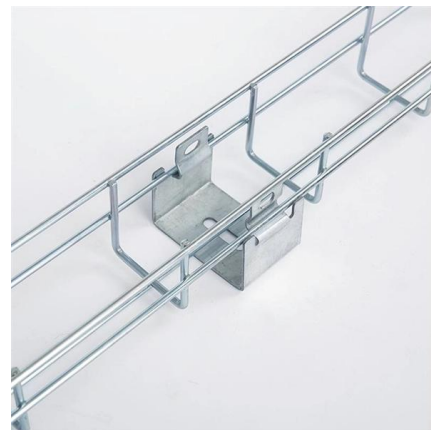

Europe Fiber Optic Connectors Market Size & Forecast

Analysis Market Size and Future Outlook The Europe Fiber Optic Connectors Market would witness market growth of 9.2% CAGR during the forecast period (2022





Fiber Optic Connectors and Adapters , FemoTech GmbH

FEMOTECH GmbH manufactures a wide variety of standard fiber optic connectors from different metals, optionally with metal or ceramic ferrules and bore diameters

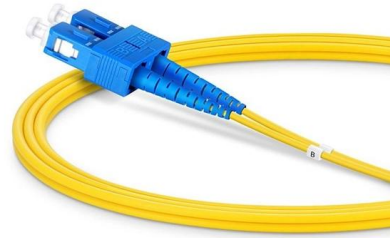

Top 20 Fiber Optical Fiber Cable Suppliers

Several companies across the continent are leading the way in producing high-quality, innovative fiber optic solutions. This article introduces

Part Search

ECIA Authorized Fiber Optic Connectors components are available from TTI. TTI offers inventory, pricing, & datasheets for Fiber Optic Connectors components from major suppliers.



Cable structure



From standard 1U to 6U sizes to fully customized Non-standard enclosures.

Fiber Optic Interconnect Components , Fiber Products

Modular fiber optic interconnect components -- connectors, DIN rail boxes & splice enclosures. Made in Europe, 5-year warranty. Request your B2B solution now.



Fiber Optic Connector Manufacturers

Fiber Optic Connectors are an essential component of any fiber optic network that provides a secure and reliable connection between two fiber optic cables. The leading manufacturers of Fiber optic



Fiber Optic Interconnect Components , Fiber Products

For over three decades, Fiber Products has been developing innovative fiber optic solutions and modular optical fiber components for professional applications

Top Telecommunication Cable Suppliers in Europe , Reliable Solutions

Need quality telecommunication cables in Europe? Discover trusted suppliers offering Cat6, fiber optic, and multipair cables for industrial use. Compare products and connect directly. [Click](#)



Europe Wire And Cable Companies

This report lists the top Europe Wire And Cable companies based on the 2023 & 2024 market share reports. Mordor Intelligence expert advisors conducted





Fibre Optic Connectors - Mouser Europe

Fibre Optic Connectors are available at Mouser Electronics. Mouser offers inventory, pricing, & datasheets for Fibre Optic Connectors.



EuropaCable - The voice of Europe's leading wire and

The voice of Europe's leading wire, cables and cable accessories manufacturers. Europacable represents the largest cable and cable accessories makers in the

Fibre Optic Connectors - Mouser Europe

Mouser is an authorized distributor for many fiber optic connector manufacturers including Amphenol, Broadcom, Glenair, Molex, Neutrik, Radiall, TE Connectivity & more.



Optical Fiber Cables Wholesale Suppliers, Manufacturers

Buy premium Optical Fiber Cables in bulk from verified wholesale suppliers and manufacturers in Europe. Best prices, bulk discounts, trusted deals at go4WorldBusiness .



Amphenol Precision Optics , Home

Experience top quality and innovation in our wide range of standardized fiber optic interconnect systems. Amphenol Precision Optics GmbH, located in Sinn, Germany, is a leading European developer and



10 Best German Fiber Optic Cable Manufacturers

Gcabling, as a professional expert with 15+ years of experience in fibre cable manufacturing industry, has specially listed 10 best German fiber cable

AFL

AFL offers fiber optic cable, transmission and substation accessories, outside plant equipment, connectors, fusion splicers, test and inspection equipment, training

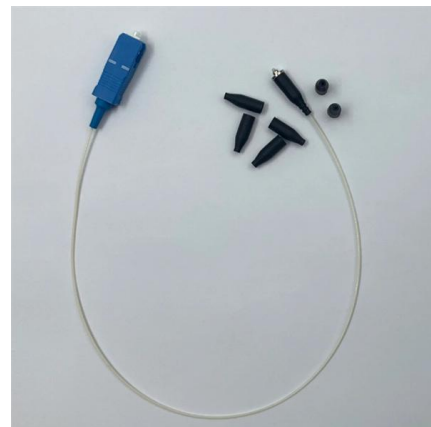



Fiber optics connector

Find your fiber optics connector easily amongst the 195 products from the leading brands (LAPP, HUBER+SUHNER, Stäubli,) on DirectIndustry, the industry specialist for your professional

Top10 Fiber Optic Cable Manufacturers in Europe

This comprehensive analysis examines the top 10 European fiber optic cable manufacturers, their market positioning, technological innovations, and



Fiber Connector Types: A Comprehensive Guide 2025

As global demand for high-speed internet, cloud computing, and data center capacity continues to grow in 2025, understanding the key components of

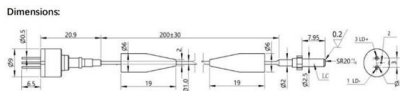

Contact Us

For datasheets, pricing, or custom telecom energy solutions, please visit: <https://koskolong.co.za>