

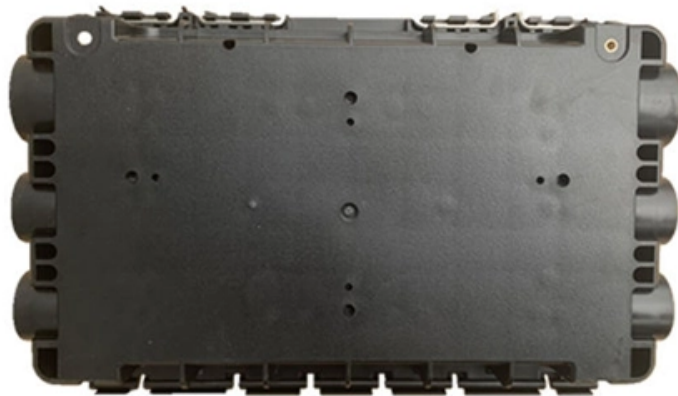

Adam Tas Corridor Energy

Price of a three-level distribution box with socket





Price of a three-level distribution box with socket

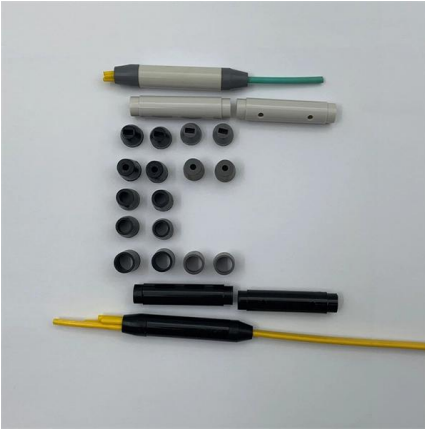

INFLX_135 3Pin 5Pin 16 Amps Industrial Plug And

Buy Influxx INFLX_135 3Pin 5Pin 16 Amps Industrial Plug And Socket 63 Amps TPN With Metal DB Distribution Board for Rs.3999 online. Influxx INFLX_135 3Pin

Types and prices of distribution boxes in 2025_COLORIA GROUP

2025 Price Guide: Investing Wisely While distribution box prices depend heavily on capacity and features, we've tracked emerging patterns. Expect these price points when budgeting

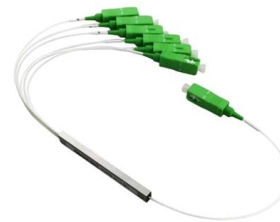

INFLX Industrial 32A 3Pin Plug and Socket with Panel

Buy Influxx INFLX Industrial 32A 3Pin Plug and Socket with Panel Board, DP MCB Distribution Board for Rs.2999 online. Influxx INFLX Industrial 32A 3Pin Plug and

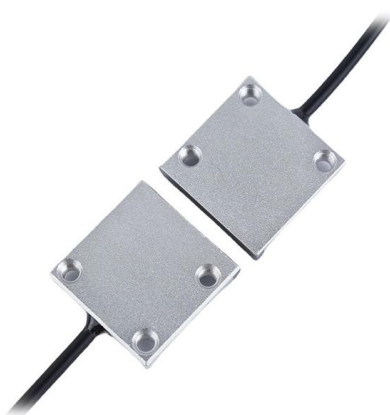

RUB185H1

The RubberBox RUB185H1 is a robust power distribution box designed to take a 63A 415V three-phase (3PH+N+E) supply and distribute it



INFLX_138 3Pin 5Pin 16 Amps Industrial Plug And

Buy Influxx INFLX_138 3Pin 5Pin 16 Amps Industrial Plug And Socket 63 Amps TPN With Metal DB Distribution Board for Rs.3999 online. Influxx INFLX_138 3Pin



Three Phase AC input & output Populated Distribution

Payflex lets you get what you need now, but pay for it over four interest-free instalments. You pay 25% upfront, then three payments of 25% over the following



Amazon .uk: 3 Phase Distribution Board

RoadEu - Power Distribution Box - 3x 13 Amp Socket and CEE 32Amp, 16Amp Socket 3P - Monophase Wall Combination Sockets with Circuit Breakers and RCD, Includes 32A, 16A and 13Amp MCB

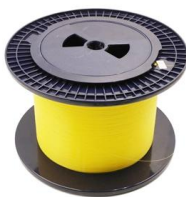



Double 32Amps 3 Pin Plug and Socket, DP MCB With

Buy Influxx Double 32Amps 3 Pin Plug and Socket, DP MCB With Metal Box Distribution Board for Rs.4000 online. Influxx Double 32Amps 3 Pin Plug and



Three Phase 12 Way Industrial plug and socket

An industrial plug and socket distribution box is a specialized electrical enclosure designed to distribute power safely and efficiently in industrial



SELVO 30 Amps TPN Distribution Board with Three Pin

SELVO 30 Amps TPN Distribution Board with Three Pin Metal Clad Industrial Plug and Socket (Fitted with 32A FOUR POLE MCB)



CEE PORTABLE DISTRIBUTION BOX WITH THREE

-PORTABLE DISTRIBUTION BOX -WITH 16A 3 PIN SOCKET (3PCS) -WITH 16A 3 PIN PLUG (1PC)
-COMPLETE EPS 40A 2POLE 30MA ELCB / EPS 16A MCB



Power Distribution Box

Trader - Retailer of Power Distribution Box - Schuko Socket Distribution Box, Electric Box Enclosures, Industrial Distribution Box and 32 Amp Console Board with

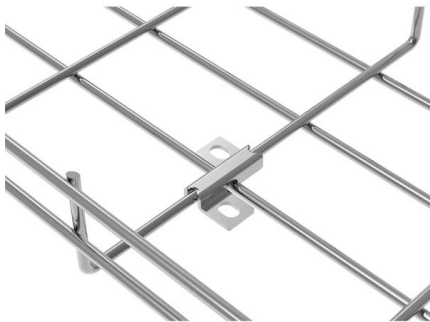

Stainless Steel Three Phase Panel Socket Db Box, Ip-67

Aman Enterprise - Offering Stainless Steel Three Phase Panel Socket Db Box, Ip-67 at INR 6500/piece in Kolkata, West Bengal. Also find Power Distribution Box price

Db 1 Phase 2 Socket & 3 Phase 1 Socket With Mcb

No dealer No distributor. Havells MCB, Sibass Plug and Socket, IP67 waterproof Enclosure. Idis India's ready made Industrial Distribution board 32 Amp with (1x)





CUBE Technologies

THE CUBE 32A three-phase power distribution box is the ideal solution for electrical distribution above 10kW. It is available in several versions for exhibitor distribution

L& T 63A 4 Module Three Pole Metal Plug & Socket Distribution

Product Details Enhance your electrical distribution system with the L& T 63A 4 Module Three Pole Metal Plug & Socket Distribution Board (DBMPS463SD). This MCB distribution board from the trusted

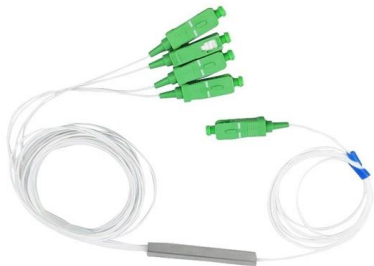

Electric Box Plug and Socket Distribution Box Industrial

Yueqing Beigang Industrial Socket Distribution Box is an electrical distribution device that adopts a plug-in method, which is more convenient and practical than

Industrial socket distribution board

Trader - Wholesaler / Distributor of Industrial socket distribution board - Industrial Plug And Socket Distribution Board, Industrial Socket Box, Schuko Socket Power





Distribution Box Cost Guide 2024: Comprehensive Pricing, Features

Discover complete distribution box cost analysis including pricing factors, advanced features, safety benefits, and smart technology innovations. Get expert insights on ROI, installation costs, and long



ELECTRRIUS Industrial Distribution Board with Plug & Socket Box

Electrrius Industrial Distribution Board with Plug & Socket Box Enclosures Sheet Metal (Without MCB) 5 Pole Three Phase IP44 Weather Proof Plug & Socket - 32 AMP

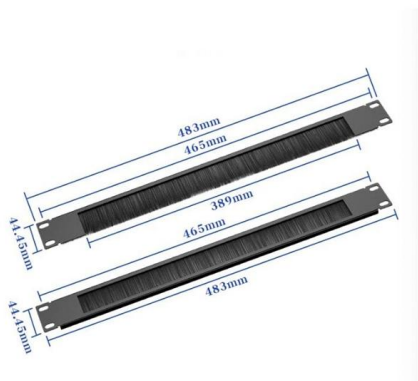

Creative Culture Creative_ 16A 3 Pin Plug and Socket DP RCCB With

Buy Creative Culture Creative_ 16A 3 Pin Plug and Socket DP RCCB With Metal Box Distribution Board Distribution Board for Rs.4599 online. Creative Culture Creative_ 16A 3 Pin Plug and Socket DP

Power Distribution Box

Find here Power Distribution Box, electric distribution box manufacturers, suppliers & exporters in India. Get contact details & address of companies



PCE ISCHL Power Distribution Box 63A 5 Pin 400V 3

Made in the UK, these heavy duty power distribution units are suitable for all industrial machinery, engineering, welding, event, marquee, catering,



Industrial Plug & Socket Panel 32 A Three Phase

Introducing the Industrial Plug & Socket Panel - 32A & 16A with 4-Pole MCB for Maximum Protection, engineered for robust and reliable power distribution in



3 phase junction box

Find 3 phase junction boxes designed for reliable three-phase electrical supply. Waterproof, CE-certified, ideal for outdoor and construction use.





Contact Us

For datasheets, pricing, or custom telecom energy solutions, please visit:
<https://koskolong.co.za>