



Adam Tas Corridor Energy

Russian OEMQSFP28 optical module 25G





Russian OEMQSFP28 optical module 25G



Generic Compatible QSFP28 100GBASE-SR4 850nm 100m DOM

100GBASE-SR4 QSFP28 Optical Transceiver Module (MMF, 850nm, 100m, MTP/MPO, DOM)
The 100GBASE-SR4 QSFP28 Optical Transceiver Module is designed for use in 100GBASE Ethernet

SFP28 o QFSP28 Optical Modules for Sale , Cables on Demand

SFP28 o QFSP28 Optical Modules Amphenol 25G
SFP28 Optical Transceiver Modules and 100G
QSFP28 Optical Transceiver Modules Available
Now in SR (Short-Range) Multimode and LR
(Long



25G optical modules for your network

A practical guide to selecting and implementing 25G optical modules based on network needs and equipment compatibility.



Demystifying SFP28: The Essential Guide to 25G

SFP28 is a 25G transceiver module for fast, efficient data transfer in modern networks,



offering high speed, compatibility, and energy savings.



Intel Compatible E25GSFP28SRX 25G SFP28 Module

Intel compatible E25GSFP28SRX Optical Transceiver supporting 25Gbps data rate in 100m distance over Multi-Mode Fiber (MMF), LC connectors



MSA-Compliant SFP-25G-LR-S SFP28 Module, 25Gbps

MSA-Compliant SFP-25G-LR-S SFP28 Module, 25Gbps Single Mode Fiber (SMF), 10km (6.2mi), LC Connector, 1310nm, MSA 25 Gigabit Optical Transceiver

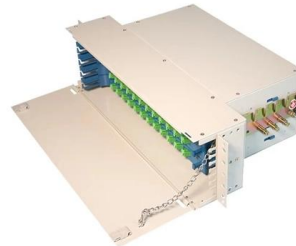

QSFP28 optical transceivers , Smartoptics

By providing four lanes of 25G, QSFP28 enables a streamlined upgrade path from lower-speed networks, making it a popular choice for scaling data center



Features and Benefits of Cisco 25G, QSFP and

Cisco 10G/40G and 25G/100G portfolio Cisco 25G portfolio and cabling specifications Cisco 100Gb optics modules The Cisco 100G BASE CFP2



25G SFP28 Transceiver Module Types and Applications

25G Standard SFP28 Transceiver Module The SFP28 transceiver modules are key components in high-speed optical networks, offering versatile solutions for various distances and

100Gb/s QSFP28 Transceivers

Amphenol's 100G QSFP28 optical modules include SR4, AOC, AOC break out, CWDM4, LR4, ER4 Lite, ER4 and ZR4 series, which adopt LC or MPO optical ports and are compatible with IEEE802.3bm,



25G Multi-Mode Optical Module

SFP28 transceiver that supports 25G connections up to 100 m using multi-mode fiber with a duplex LC UPC connector.



2. Imported design is convenient for expansion.

The design of two inlets saves space and allows for rear line entry.

QSFP28 Transceiver: The Ultimate 100G Optical

Discover ascentoptics about QSFP28 transceiver solutions. Master 100G optical modules with in-depth insights and trusted guidance.

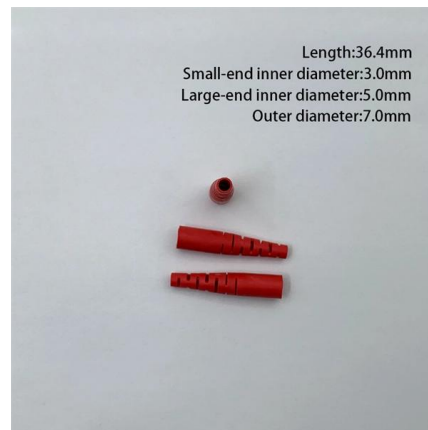

25G SFP28 Optical Transceivers , Transceiver Modules

Buy online 25G SFP28 transceivers at QSFPTEK for 25Gigabit Ethernet, high-speed servers, storage, and data center backbone. QT SFP28 includes 25GBASE-SR/LR/ER, from 100m to 40km.

Optimizing Network Upgrades with FS 25G SFP28 Modules

Discover how FS 25G SFP28 modules provide an efficient, cost-effective solution for network upgrades, addressing the rising demands of digital transformation.





QSFP28 optical transceiver modules that use MPO connectors



QSFP28 modules are designed to operate with 4 channels of 25G (the "Q" stands for Quad) resulting in a combined bandwidth of 100G links. QSFP28 ports are also compatible to support QSFP+ which

QSFP28 optical transceiver modules that use MPO connectors

100G QSFP28 optical transceiver modules that use MPO connectors QSFP28 modules are designed to operate with 4 channels of 25G (the "Q" stands for Quad) resulting in a combined bandwidth of 100G

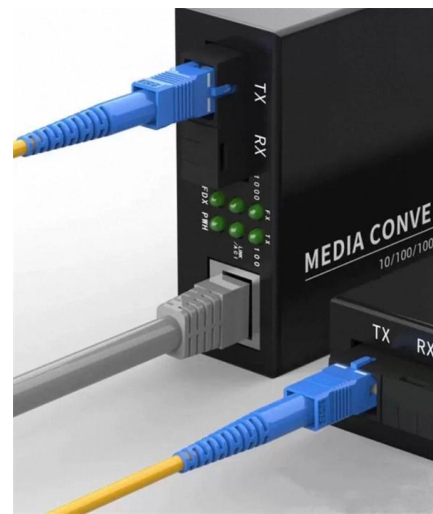

25G SFP28 Optical Transceiver Modules , FiberMall

FiberMall offers 25G Optical Transceiver Modules, which is compliant with the Multi-Source Agreement using Small Form-Factor Pluggable (SFP28) footprint.

Models, specifications, and compatibility

Models, specifications, and compatibility QSFP28 optical transceiver modules provide a transmission rate of 100 Gbps.



25G SFP28

The 25g SFP28 modules produced by SULITON are suitable for most switch brands on the market, such as MSA, Cisco, Huawei, Juniper, Dell, Edge-Core and other

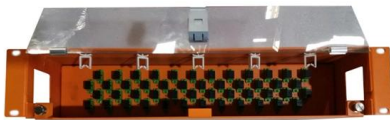

UniFi 25G Multi-Mode Optical Module

SFP28 transceiver that supports 25G connections up to 100 m using multi-mode fiber with a duplex LC UPC connector.



SFP28 25G LR Transceiver: Complete Guide for 25G Ethernet

SFP28 transceivers are commonly used in 25G Ethernet switches, network interface cards (NICs), and routers across data center, enterprise, and telecom environments. The SFP28 25G LR transceiver is



Opticheskie moduli QTECH

Kompaniya QTECH proizvodit opticheskie moduli tipa SFP28 25G, otlichayushhiesya men`shim razmerom i nizkim e`lektropotrebleniem. Danny`j tip modulej aktivno primenyayut pri

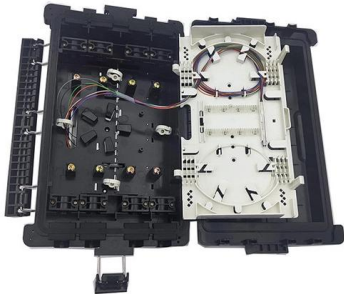

25G SFP28 Optical Transceiver Modules

FS 25G SFP28 transceiver solutions offer a wide variety of high-density and low-power 25 Gigabit Ethernet connectivity options for data centre and high-performance computing networks applications.

25G SFP28 Transceivers , Optical Transceivers

Amphenol 25G SFP28 optical transceiver includes SR, LR Lite, LR, ER, etc, adopt LC interface and compatible with IEEE802.3by, IEEE802.3cc, SFF



100G QSFP28 Transceiver Modules , Optical

FS offers a growing portfolio of 100G QSFP28 modules. The 100G QSFP28 module solution provides high-performance 100GbE connectivity for data centres,



An In-depth Guide to 25G SFP28 Optical Transceiver

Discover the advantages, specifications, and applications of 25G optical transceiver solutions--for high-speed data center, enterprise, and telecom networks.

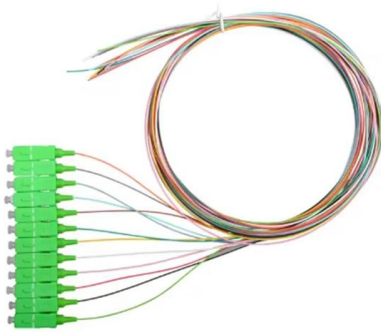

25G/40G Optical Transceiver Modules

Buy 25G and 40G fiber optic transceivers for high-bandwidth migration at QSPFTEK online store. Cost-effective, compatibility guaranteed and same-day shipping.

SFP28 or QSFP28 Optical Modules for Sale , Cables on Demand

With data throughput in excess of 28.0 Gbps per lane, our 1X (1 x lane) SFP28 Optical Module (SR/LR) is perfect for use with 25-Gigabit (25G) Ethernet and our 4X (4 x lane) QSFP28 Optical Module

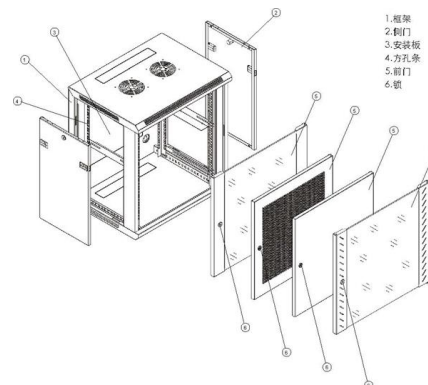



25G SFP28 Transceiver

QSFPTEK offers a 25G SFP28 high-performance Active Optical Cables integrated cable that can provide an ideal alternative solution for high-speed cables and short-distance SFP28 optical modules.

Customized 25GBASE-SR SFP28 Transceiver Module

Customized 25GBASE-SR SFP28 Optical Transceiver Module (MMF, 850nm, 100m, LC, DDM) The customized 25G SFP28 transceiver module is equipped with LC



25G SFP28-Modul - Key2optics - Total OTN Solutions

Das optische 25G SFP28-Modul umfasst SR, LR, SFF-8472, SFF-8431 und andere Standards, geringer Stromverbrauch, geeignet für Ethernet und Fibre Channel.

Contact Us

For datasheets, pricing, or custom telecom energy solutions, please visit:
<https://koskolong.co.za>