



Adam Tas Corridor Energy

The distribution box needs to be debugged





The distribution box needs to be debugged



The installation requirements for the distribution box

Learn how to install a distribution box safely and correctly. Covers wiring, placement, standards, and expert tips for a compliant setup.

Set debug and release configurations

Set debug and release configurations in Visual Studio. You build the debug version for debugging and the release version for the final release distribution.



Debugging Errors and Warning Dialog Boxes

See a list of errors and warning dialog boxes that you might encounter while debugging your application in Visual Studio.

Deployment methods for distributing test stations

Hi, I'm wondering what's the most proper method of code deployment in my case and I



hope we can have a good discussion about it here. Quick introduction: I have one development test



Comprehensive Guide to Septic Systems and Distribution Boxes

Introduction to Septic Systems and Distribution Boxes Septic systems are a crucial component of wastewater management for homes and businesses not connected to municipal sewer

Android debugging won't start. Says "needs to be deployed before it"

It deploys fine but then gives the "needs to be deployed before it can be started" error. Additionally, everything will work fine for me if I have the solution in the same folder as my project. If I



SOLVED

We're on Microsoft Config Manager 5.00.9122.1018, on Windows Server 2019. When working on OSD Task Sequences, we learned the content for



PROBLEMS ALREADY! How To Replace Septic Distribution Box.

There are two issues the distribution box is deteriorating and the leach field is seeping up due to hydraulic pressure. It may just need some healthy bacteria introduced to clean up the drain bed.

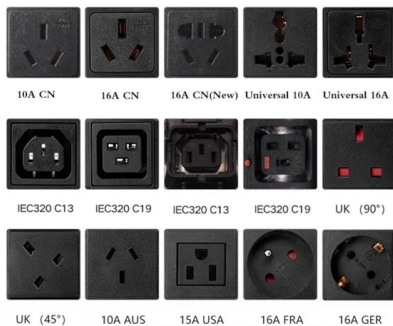

MAUI Blazor Hybrid - Fixing the "This project needs to

The application should now start, but it's also possible that you're now seeing the same error box, with a different error in the error list: It may

What is a Septic Distribution Box: A Clear Explanation

What does a septic distribution box look like? A septic distribution box is typically made of concrete or plastic and is installed below ground level between the septic



Debugger is not working on Visual Studio 2022

I am using Visual studio 2022 with Framework 6.0 while i am trying to debug application not hit the breakpoint at the starting point. try to apply

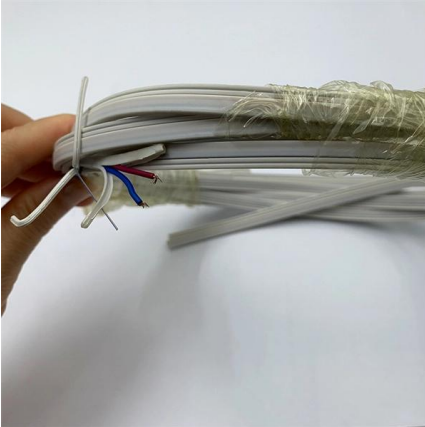

Septic System D-Box Definition, Location, Repair

Septic system D box installation, specifications, inspection, diagnosis, and repair: How to find the septic distribution box, drop box, or D-box



Microsoft Dev Box deployment guide

Learn about the process, configuration options, and considerations for planning a Microsoft Dev Box deployment.



Debug your app , Android Studio , Android Developers

The device will need to restart in order to begin debugging. To keep the same instance of the app running, click Cancel Debug and instead attach the debugger





The Distributor has not been installed correctly. Could

Configures a Publisher to use a specified distribution database. This stored procedure is executed at the Distributor on any database. Note that the

The ultimate guide to debugging

Debugging is a useful skill in programming that will help you find bugs much quicker that could otherwise be hiding in your code. Everyone writes bugs, even the best programmers. The best

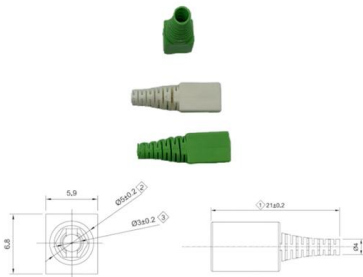

visual studio

Please try with the steps below: Right click on the Visual Studio Project - Properties - Debug - (Start Action section) - select "Start project" radio

Distribution Box Guide: Types, Components & Solutions

Understand distribution boxes (DB boxes) in 5 minutes. Learn about types, components, functions, and uses. Find the perfect DB box for your needs.

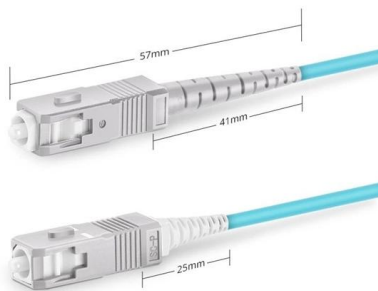
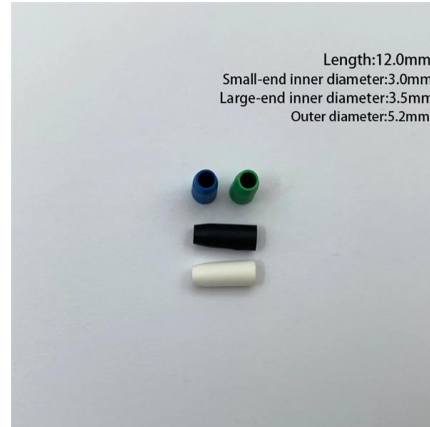

Simplex SC UPC

How to Install SCCM Distribution Point , ConfigMgr DP

In this article, I will show you how to set up or install SCCM distribution point. We will look at ConfigMgr DP Installation and Configuration

Getting warning message telling me that I'm debugging

I've checked all possible causes for this dialog box to appear, but not of them applies. The code is built correctly, .pdb files are created and copied to

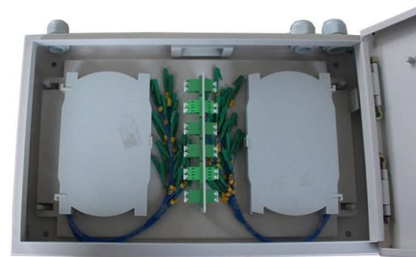

Cant Run MAUI Project getting below Error

I don't know who needs it but this solved my issue when working on



Question: The project needs to be deployed before we

Simultaneously a "The project needs to be deployed before we can debug" dialog appears - and "Deploy" checkbox is selected. Issue disappears



The Ultimate Guide to Distribution Box Types

Discover the key types of distribution boxes with NUOMAK's comprehensive guide. Learn about Main Distribution Boards (MDB), Consumer Units, Transfer

Fix for Distribution Centre Box Missions in Star Citizen

Noobs Gaming Here is a great workaround for the box missions at the cargo centres in star citizen, the boxes wont be allowed to be picked up and this will fix it so you can.



How to Replace a Septic Distribution Box

The distribution box of the septic tank system is used to evenly distribute the wastewater from the septic system to the dispersal field. Over time,



Understanding Septic Tanks: The Role of Distribution Boxes Explained

Explore the role of distribution boxes in septic systems and get practical tips for effective maintenance and management.

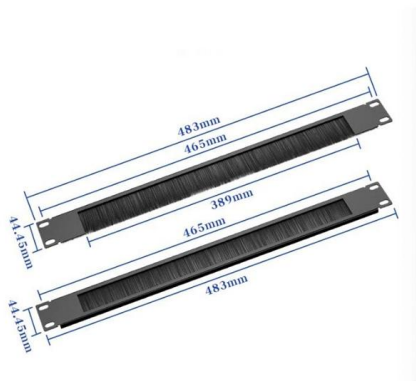

Septic System D-Box Inspect & Repair

Septic system D box inspection & problem diagnosis: procedures for inspecting or diagnosing problems at the the septic drainfield distribution box, or the D-BOX OR DROP BOX. IF THE D-box is leaking,

7 Signs Your Septic Distribution Box Is Failing & How to Fix

The Hidden Linchpin: How Your Septic System's Distribution Box Protects Your Home (and Wallet)
For millions of homeowners, particularly in rural and suburban areas, a properly

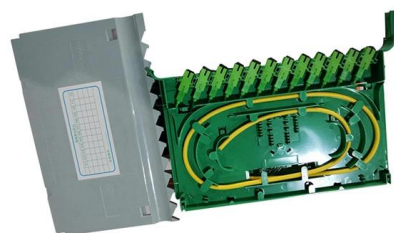

WinUI Desktop debug fails with: The project needs to be

To pick up a draggable item, press the space bar. While dragging, use the arrow keys to move the item. Press space again to drop the item in its new



Mesh door/glass door optional



Sp-601 glass door



Sp-602 mesh door

Contact Us

For datasheets, pricing, or custom telecom energy solutions, please visit:
<https://koskolong.co.za>