



Adam Tas Corridor Energy

Top 10 Cable Tray Brands in China





Overview

The top ten brands in the cable tray industry are: Weifang Guqiang, CABLOFIL, DAQO, HUAPENG, MEETALL, ONEQ, OBO, ZHENDA Electric, Beijing Changhe, and UONONE. Bonet Cable Tray specializes in the manufacturing of wire mesh and basket cable trays, providing high-quality solutions for various applications such as network and electrical cable management. Their products are designed for durability and efficiency, ensuring compliance with international standards. Understanding the top factories in China is crucial for making informed decisions. - Materials: Hot dip galvanized steel, stainless steel, PVC, fiberglass, aluminum. is a leading manufacturer specialized in developing, producing and selling of silicone material products, our product range including silicone travel bottle set, silicone collapsible water bottle, silicone cup, silicone baby feeding set, etc. Whether you're managing a chemical plant or a data center, selecting the right manufacturer ensures safety, efficiency.



Top 10 Cable Tray Brands in China

Cable Tray Market , Global Market Analysis Report

Cable Tray Market is expected to reach USD 5.4 billion and likely to surge at a CAGR of 2.4% during forecast period from 2025 to 2035.



Top 10 Electrical cable tray manufacturers Companies and Products

Product Details: Cable tray systems are used to support insulated electrical cables for power distribution, control, and communication. They are an alternative to open wiring or electrical conduit systems,



Top 100 Cable Tray Manufacturers in China (2026) , ensun

Identify and compare relevant B2B manufacturers, suppliers and retailers. Bonet Cable Tray specializes in the manufacturing of wire mesh and basket cable trays, providing high-quality solutions for various



Top Solar Cable Tray Brands China: Guide for Optimal Installation

Innovative Solar Cable Tray Solutions from Leading Chinese Manufacturers Today's solar



cable trays from top Chinese manufacturers aren't just metal conduits; they're engineered

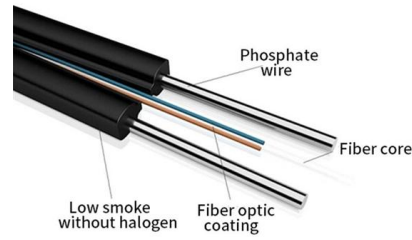

Best 5 Cable Tray Manufacturers in China

Discover the top cable tray manufacturers in China, offering a range of high-quality products for industries such as construction, energy, and



What are the Top 6 China Cable Tray Manufacturers?

From material expertise to production capacity, we'll explore what sets these manufacturers apart, complete with a



Best Cable Tray Manufacturers in China

TOP 10 Cable Tray Manufacturers 1. Shenzhen Xinnengda Silicone Products Co., Ltd. ? 2. Jiangsu Wancheng Machinery Co., Ltd. ? 3. Hebei Ansha New Material Technology Co., Ltd. ? 4. Pinno Electric





China Cable Trays, Cable Trays Wholesale, Manufacturers, Price

Design engineers or buyers might want to check out various Cable Trays factory & manufacturers, who offer lots of related choices such as cable tray, wire mesh cable tray and galvanized cable tray.



Best Cable Tray Brands for 2025

Discover the top cable tray brands in 2025 offering durability, fire resistance, and industrial-grade quality. Compare verified suppliers, pricing, and features. Click to find the best fit for

Best Wire Mesh Tray Brands China: Buyer's Guide with Top

Discover leading wire mesh tray brands in China with our comprehensive guide. Compare top manufacturers, learn key selection factors, cost analysis, installation tips, and read real customer



Top 10 Electrical cable tray manufacturers China Products Compare

Frequently Asked Questions (FAQs) 1. What types of cable trays do manufacturers in China produce? Manufacturers in China produce a wide variety of cable trays, including ladder trays, perforated trays,



Top Cable Tray Brands for Reliable Cable Management

Discover the best cable tray brands known for high-quality, durable, and compliant cable management systems tailored to your project needs.



Cable Tray Companies

This report lists the top Cable Tray companies based on the 2023 & 2024 market share reports. Mordor Intelligence expert advisors conducted extensive research and identified these brands to be the

LONGJOY Cable Tray

Excellent cable manufacturer & supplier from China, whose products have passed CE & VDE certification. Supplying cable meat IEC, DIN, BS, etc

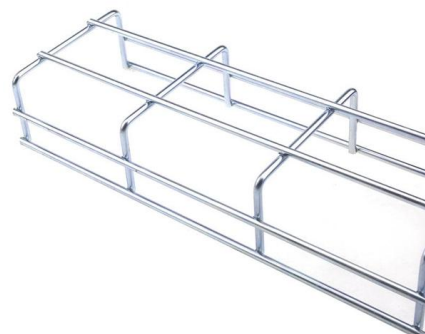



Industry Watch: Top 10 Premium Cable Tray Brands for 2026

The top ten brands in the cable tray industry are: Weifang Guqiang, CABLOFIL, DAQO, HUAPENG, MEETALL, ONEQ, OBO, ZHENDA Electric, Beijing Changhe, and UONONE.

Top 10 Electrical cable tray manufacturers China Products Compare

Dive into our comprehensive comparison of the leading electrical cable tray manufacturers in China and discover the best options for your next project! Product Details: Cable trays including cable trunking,

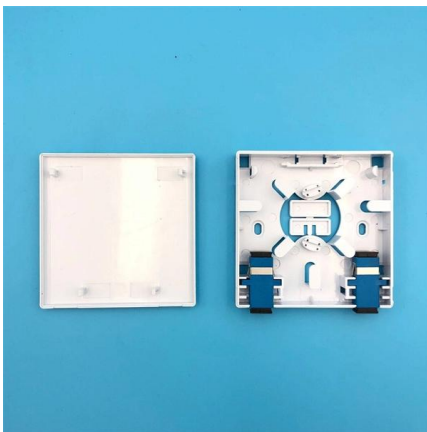
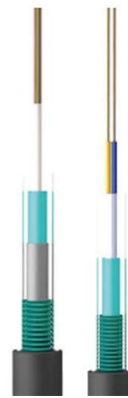

Top 10 Cable tray China

Understanding the top factories in China is crucial for making informed decisions. By knowing the best options, you can ensure quality and reliability for your projects. Dive in to discover the leading

Top Cable Tray Brands for 2025

Discover the best cable tray brands offering durable, customizable solutions. Compare materials, pricing, and supplier reliability. Click to find top-rated brands with verified suppliers and



Top 10 Cable tray manufacturer China Products Compare 2025

Are you in the market for reliable cable trays but overwhelmed by the options? You're not alone! With numerous manufacturers in China, choosing the right factory can make all the difference in quality



China's Top 10 PV Cable Tray Suppliers for Solar Power Solutions

Explore China's leading PV cable tray suppliers offering innovative solutions for solar power installations. Discover durable materials and advanced technologies that enhance efficiency

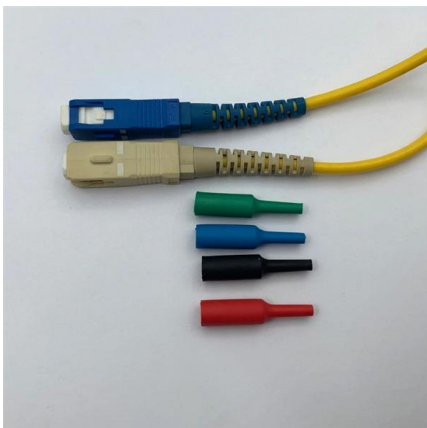

Top 100 Cable Tray Manufacturers in 2026 , ensun

Top Cable Tray Manufacturers The B2B platform for the best purchasing decision. Identify and compare relevant B2B manufacturers, suppliers and retailers



Industry Watch: Top 10 Premium Cable Tray Brands for 2026

The recently released Top 10 Cable Tray Brands ranking was compiled through a comprehensive evaluation across multiple dimensions, including brand strength, market feedback,

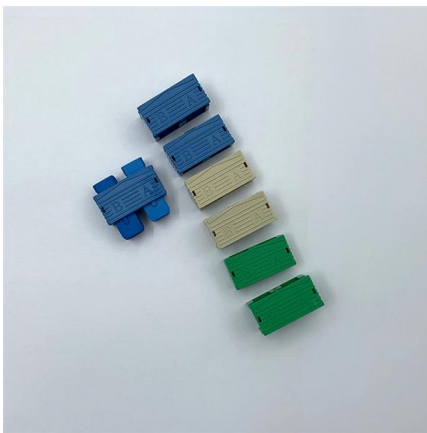

Top 10 Wire Mesh Tray Companies in China: Leading Manufacturers

Discover China's top 10 wire mesh tray companies offering efficient cable management solutions. This guide covers leading manufacturers, suppliers, quality standards, and installation tips

Top 10 Aluminum cable tray manufacturers China Products Compare

Aluminum Cable Tray Manufacturers and Suppliers - China Factory - ZP Product Details: Aluminum cable tray made of 1060 aluminum plate with 99.6% aluminum content, offering a service life over 5



Top 10 Cable Trays Manufacturers And Suppliers , B2B

This list of top 10 online B2B marketplaces and manufacturers will lead you to find your perfect cable trays based on your business requirements.



Top 10 Cable Tray Manufacturers & Suppliers List

Discover A List of Top 10 Cable Tray Manufacturers and Suppliers offering premium quality solutions for all industries. Choose JP Shine Electrical & Controls Pvt Ltd, a trusted name in the industry, known

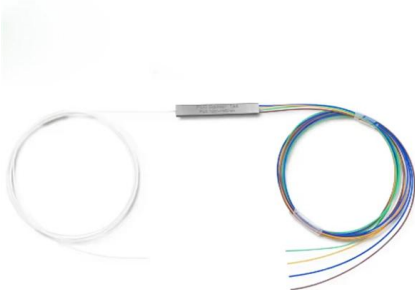

Premium Cable Tray Systems from China: Advanced Cable

Discover high-quality cable tray systems manufactured in China, featuring advanced corrosion protection, versatile designs, and comprehensive quality control for reliable cable management

Top 10 Supplier cable tray China Products Compare 2025

Are you in the market for high-quality cable trays and wondering where to find the best suppliers in China? With so many options available, it's crucial to compare the top factories to ensure you make

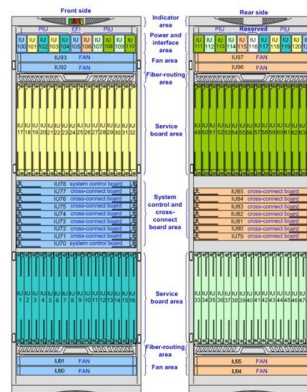



Cable Tray Suppliers: How to Select Top Manufacturers in China

Where to Find Cable Tray Supplier Suppliers? Key manufacturing regions for cable tray suppliers are concentrated in China, particularly in industrial clusters within Zhejiang, Shanghai, Jiangsu,

Home

Shandong Tianhong Electric Power Technology Co., Ltd. is a leading cable tray manufacturer in China, founded in 2006. With over 20



Contact Us

For datasheets, pricing, or custom telecom energy solutions, please visit:
<https://koskolong.co.za>