

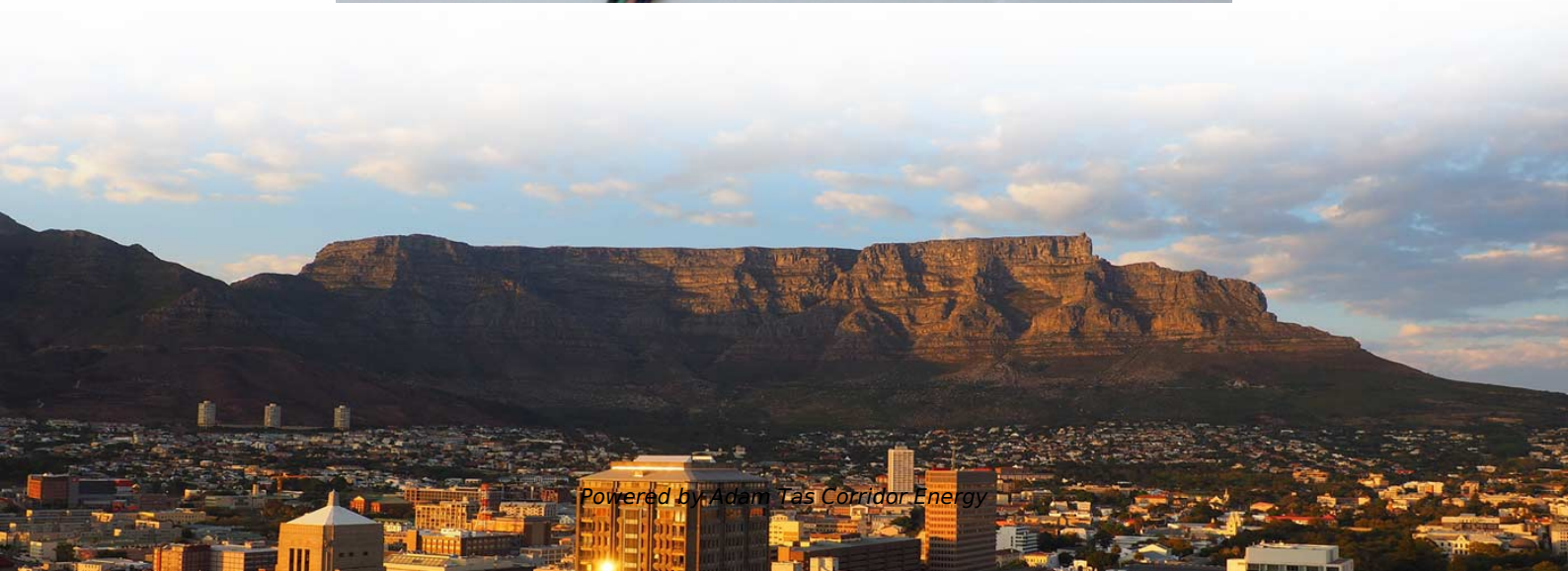

Adam Tas Corridor Energy

What interface is the optical module used with





What interface is the optical module used with

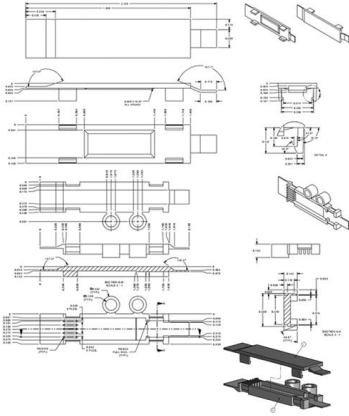

Understanding Optical Modules: Working Principles,

Explore the working principles, structures, and performance metrics of optical modules, essential components of optical fiber communication systems. Learn

Understanding Optical Modules: Types and

An optical module is mainly composed of optoelectronic devices (including the optical transmitter and optical receiver), functional circuitry, and optical interfaces. Its



What Is an Optical Module and Its FAQs (V300)

As an important part of fiber-optic communication, an optical module is a photoelectric converter which converts electrical signals into optical signals and vice versa. An optical module

HMS Networks

HMS creates products that enable industrial equipment to communicate and share information with software and systems. In short:



Comprehensive Analysis of Optical Module: Detailed Explanation of

Optical module is a key optical fibre communication device, its main function is to convert electrical signals into optical signals and transmit data through optical fibre media. Classification of

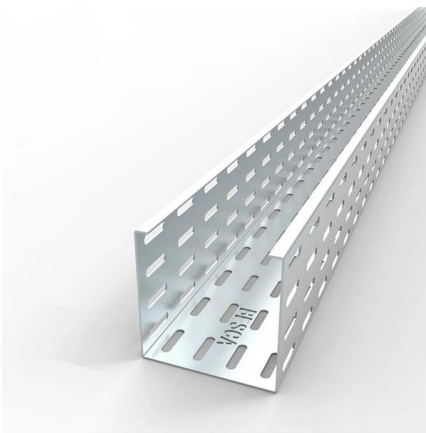

Cisco OSFP 800G Transceiver Modules Data Sheet

The OSFP 800G transceiver modules are Cisco's new generation of pluggable transceiver modules based on the OSFP specification. They offer



What is an Optical Module?

An optical module typically consists of an optical transmitter (TOSA, Transmitter Optical Sub-Assembly, containing a laser diode), an optical receiver (ROSA,



What is an optical module? Optical module wiki

An optical module, also called fiber optic transceiver or optical transceiver, is a typically hot-pluggable device used in high-bandwidth data



Understanding Optical Modules: Working Principles,

The working principle of optical modules is illustrated in the diagram shown in the Optical Module Working Principle Diagram. The transmitting interface inputs

Global Leader in Materials, Networking, and Lasers

Learn how Coherent empowers innovations and breakthrough technologies for the industrial, communications, electronics, and instrumentation markets.



How to Choose Optical Modules Correctly?

An optical modules typically integrates an optical transmitting device (TOSA, with a laser), an optical receiving device (ROSA, with a photodetector),

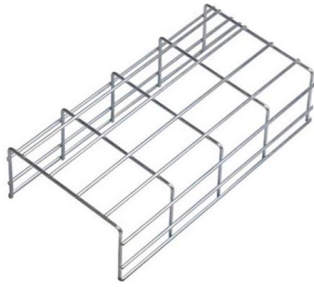

Optical module

Optical modules can either plug into a front panel socket or an on-board socket. Sometimes the optical module is replaced by an electrical interface module that implements either an active or passive

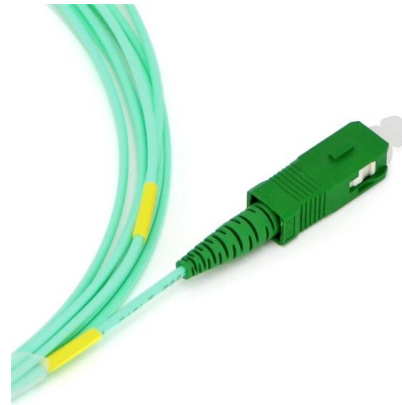

Fiber optical module and common knowledge of optical interfaces

Fiber optic technology has revolutionized the way we transmit and receive data. With its ability to transmit large amounts of data over long distances with minimal signal loss, fiber optics has

direcXource Ciena QSFP28-SR4 Compatible 100GBASE-SR4

Ciena QSFP28-SR4 compatible optical transceiver is a parallel 103.1Gbps Quad Small Form-factor Pluggable QSFP28 module for use in 100GBASE Ethernet. QSFP28 SR4 provides 100Gb/s





Cisco 400G QSFP-DD High-Power (Bright) Optical

Learn how Cisco 400G QSFP-DD High-Power (Bright) Optical module's small size and low power make it an optimal choice for a wide range of

Understanding Optical Modules: A Comprehensive Guide

Optical modules support various transmission standards and protocols, including Ethernet, Fibre Channel, and SONET/SDH. They also

Focus creates quality products



What is Optical Transceiver: A Beginner Guide (2024)

What is an Optical Transceiver? An optical transceiver, also known as a fiber optic transceiver or optical module, is a small packaged device that uses

Lumentum

Lumentum Holdings Inc. ("Lumentum"), a global leader in photonic solutions, today announced its showcase of technology and product demonstrations designed to meet the



The Most Comprehensive Guide Of Optical Modules

Fiber optic connector here refers to the interface where the optical module connects to a fibre optic patch cable, which can be connected via a single-mode or multi-mode fibre optic cable.



What is an optical module? Optical module wiki

Transceiver modules typically have an electrical interface on the side that connects to the inside of the system and an optical interface on the other

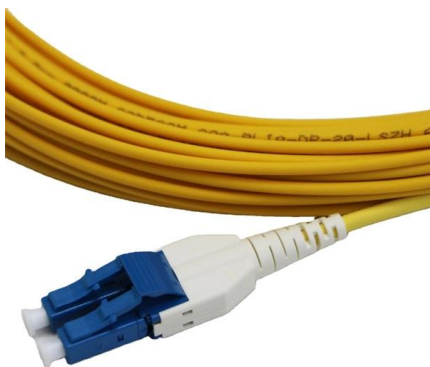
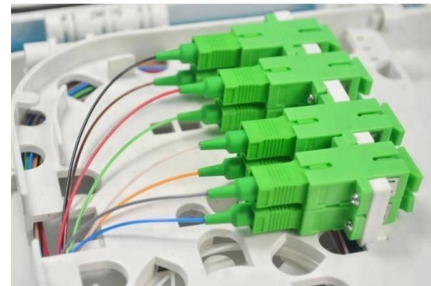

What Is an Optical Module and Its FAQs (V200)

Describes what an optical module is and FAQs, including the fundamentals, appearance and structure, key performance counters, common types, and naming conventions of optical modules, causes of



Cisco QSFP-DD and OSFP 800G ZR/ZR+ Coherent

These digital coherent optics modules enable 800G traffic over amplified DWDM links up to 120 km for 800ZR and over 1000 km for 800G ZR+.



Common Optical Modules and Interfaces for Switches

Common optical module types such as SFP, GBIC, XFP, and XENPAK, along with optical interfaces like FC, SC, and LC, each have their unique characteristics that make them suitable for

Optical module - A comprehensive exploration

The optical module is composed of optoelectronic devices, functional circuits, and optical interfaces. It mainly performs photoelectric and electro-optical



Cisco QSFP28 100G ZR Digital Coherent Optics Module Data Sheet

The Cisco QSFP28 100G ZR leverages the latest Common Management Interface Specification (CMIS) 5.2 management interface specification and is compliant to coherent CMIS. The

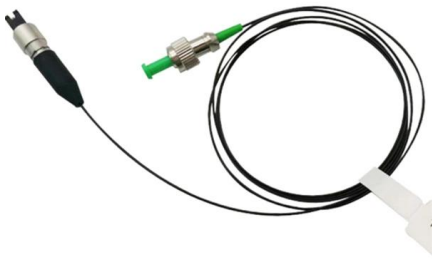

Everything You Need to Know About Optical Modules

Optical Interfaces and Electrical Signals Optical modules use electrical signals to convert them into optical signals that can be transmitted over long

Outline drawings
mm

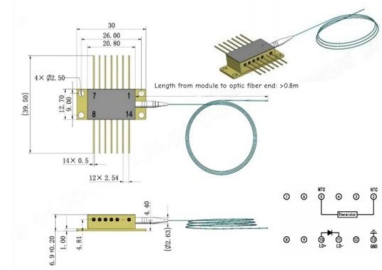

What is an Optical Module?

Learn about the different types of optical modules, their functions, packaging, and key technical concepts like 400G, PAM4, and more. Understand how optical modules enable high-speed data

Contact Us

For datasheets, pricing, or custom telecom energy solutions, please visit:
<https://koskolong.co.za>