



**Adam Tas Corridor Energy**

# **Why can't I use it after unplugging the pigtail cable**



American-style Simplex





## Overview

---

A connector that is too small or too large can result in a weak or loose connection. Voltage and Current: Check the voltage and current ratings to ensure the pigtail connector can handle the power passing through it. Since moving to college I don't use my home PC much anymore (its about 5/6 years old), I usually turn off the power supply using the switch and unplug it from the wall to protect it from power surges while I'm gone. After getting home and not having used it for about a month I turn everything back. GPU with 2x 8 pin - only acceptable if you have no other option and your card usually never exceeds around the 160w range under load. Stress Relief: Pigtail connectors protect wires from pull-through, twisting, or other stress, preventing damage that.



## Why can't I use it after unplugging the pigtail cable

---



### Electrical Pigtails

Q. When does the electrical code require pigtails for connecting devices in residential wiring? A. Ben Giles, licensed electrician and owner of

### are pigtail PSU cables really bad? : r/buildapc

When you use a pigtail for one of the receptacles instead of a different set of leads, what you get is the electrical equivalent of having just one plug connected to the card, and that means you risk pushing

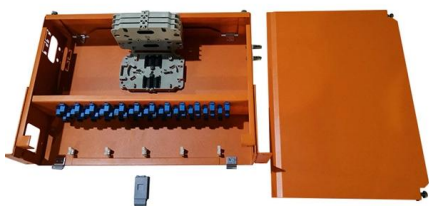

### How To Repair Pigtail Connector?

It outlines seven easy steps to replace a pigtail connector, making it accessible for DIY enthusiasts and individuals dealing with electrical issues. Key

### Does leaving just the pigtail plugged in use electricity?

I'm expecting to do most of my charging at work and only use the 14-50 at home when I need



extra range, hence why I was asking about leaving the pigtail hanging at home.



### What is a Pigtail Connector? A Complete Guide

A: Pigtail connectors can flexibly connect multiple wires and protect connection points, such as reducing cable tension in electrical wiring, and comply



### Monitor Flickering after Nvidia Upda , NVIDIA GeForce Forums

It doesn't make sense to me at all why it would work without flickering after unplugging and re-plugging, yet had no effect after jiggling and tightening the cables



### How To Unplug Ethernet Cable

Learn how to properly unplug an Ethernet cable without causing any damage or disrupting your network connectivity. Follow these step-by-step

Integrated Aluminum Alloy Die Casting



Durable and Secure Metal Screws





## Why Use A Pigtail When Wiring An Outlet?

In other tutorials, I've talked about how to create a pigtail when wiring up an electrical outlet. What I haven't really addressed previously is the "why"



## Troubleshooting Guide: Computer Not Turning On After Unplugging -

FAQs Why Is My Computer Not Turning On After Being Unplugged? There are several reasons why your computer may not be turning on after being unplugged. It could be due to a

## How to Make Pigtail Wire Connections , Angi

A pigtail electrical wire connector is a simple DIY project, whether you need to extend a short wire or connect neutral, hot, and ground wires to a circuit.

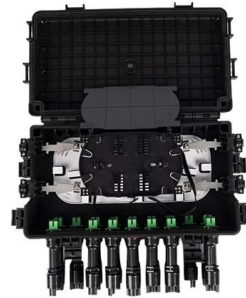

After the five minutes is up, reinstall the CMOS battery making sure to insert it with the correct side up just as it came out. If you had to remove the graphics card you can now reinstall it, but

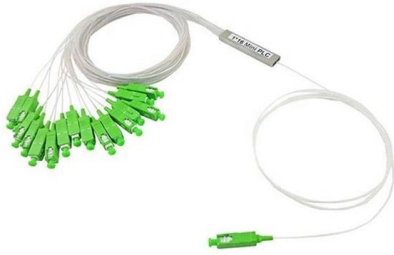

## Electrical Pigtail: 6 Steps Wiring Guide for Safe

Learn how to create an electrical pigtail for safe and secure wiring connections. Follow our step-by-step guide and essential tools list.



## Headphones wont work after unplugging them and

I've had this problem for about a month now and I cant find a fix for it. When ever i plug them in after startup a message will appear asking what I plugged in but if I

## PCI-E cable with pig tail PSU question

Therefore, it is not recommended to use a single cable that splits into two 8-pin PCIe on graphics cards that utilize two PCIe connectors to consume over 288W. Refer to the specifications of





## No sound after unplugging headphones in Windows 11/10

If you are experiencing no sound after unplugging headphones in Windows 11/10, it may be due to a software glitch or driver issue.



## Replacing Electrical Pigtail on Trailer , Forest River Forums

My first issue with this project was that, while the new cable was color coded, the camper wiring observed inside the junction box was not. Here is how I went about replacing mine so that I



## Tips for Using Pigtails To Electrify New Components in a

Learn expert tips for using pigtails to electrify new components in a car. Simplify installation, ensure safety, and improve functionality with these tips.



## How to repair automotive electrical connectors by depin

The ability to de-pin a connector is a crucial step of the pigtail repair process. This process entails removing the existing wiring and terminals from the damaged

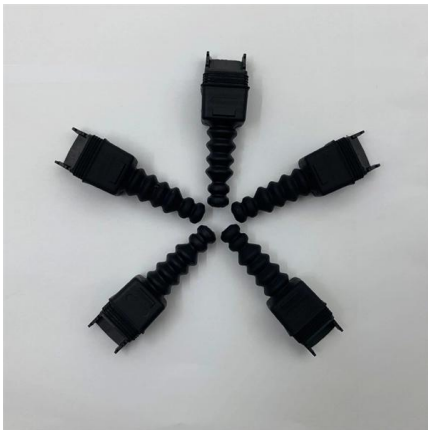

## What Is a Pigtail in Electrical Wiring?

Learn what an electrical pigtail is and why this short jumper wire is essential for safe, code-compliant connections in home wiring projects.

Whenever I unplug a USB device, be it a mouse, keyboard, or wireless dongle, I have to restart my PC for them to actually work when I plug them back in. For example, when I unplug my

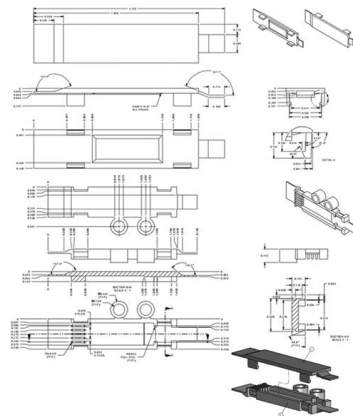

## Solved!

So I've had this problem for the past year and a half, it's mildly annoying burgeoning on infuriating at this point. Basically my headphones work perfectly fine if they are plugged in during the



## **BIG Reasons Why DIYers Should Stop Wiring Their Outlets This Way**

In this video I am going to talk about how the old way of connecting outlets may be inferior and why you might want to think about using pigtails. If you don't know how to make a pigtail, I am

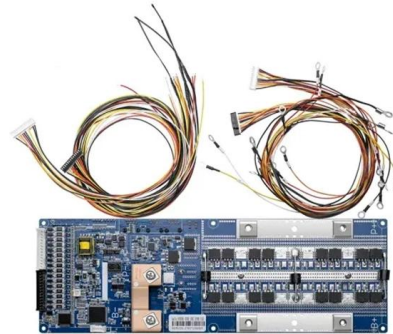

## **How to Pigtail an Outlet for a Safer Connection**

After twisting, use the wire nut to cover the splice, screwing it on clockwise until it is tight and the insulation is fully seated. A final, gentle tug on each individual wire confirms the integrity of

## **remove a broken pigtail connector from cable ? : r/computerrepair**

I was replacing the wifi card on my partner's laptop when the pigtail connector came loose from the card (explains why it wasn't working properly) and is now stuck on the cable.



## **The Complete Guide to Pigtail Fibers: Simplifying**

Pigtail fibers are the quiet enablers of modern connectivity, bridging devices to networks with precision and reliability. From 5G cell towers to AI data

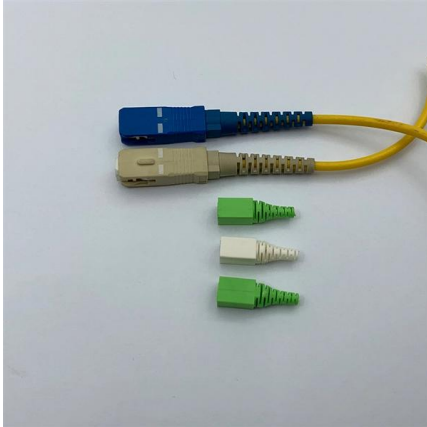

## Contact Us

---

For datasheets, pricing, or custom telecom energy solutions, please visit:  
<https://koskolong.co.za>