

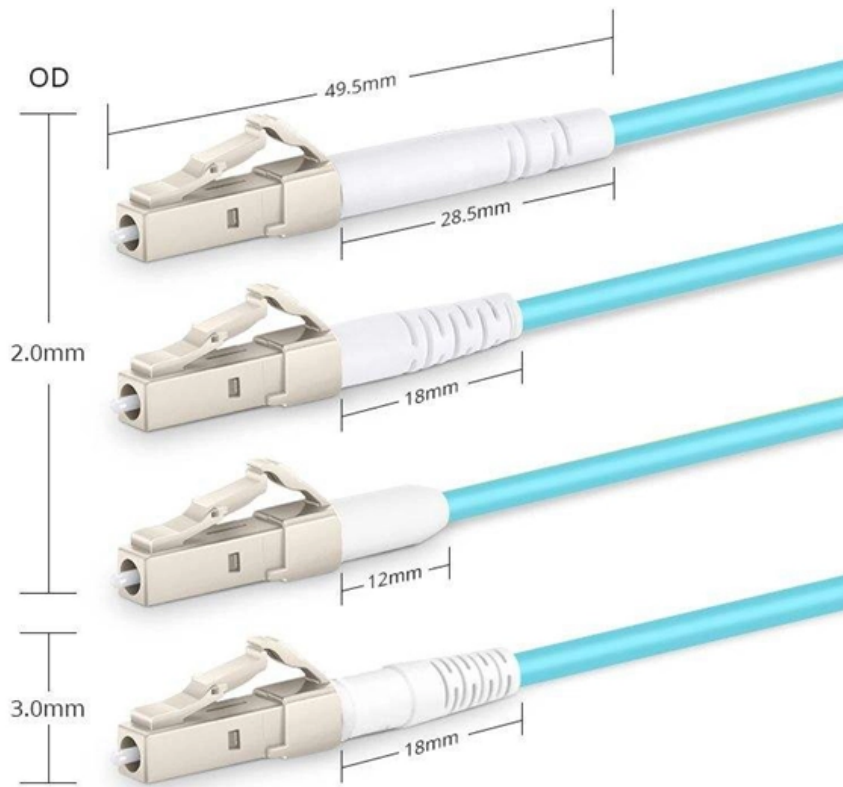

**Adam Tas Corridor Energy**

# **Wire and Cable Equipment Company**



Simplex LC UPC





## Wire and Cable Equipment Company

---

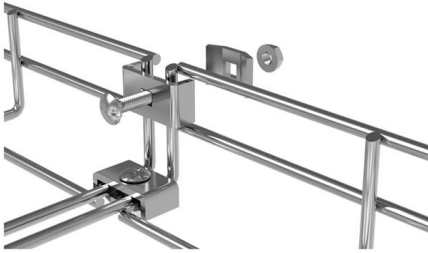

### **Cable Assembly Manufacturer, Custom Looms & Harnesses , GTK UK**

We offer a large variety of cable assemblies to meet your business needs, ranging from simple wire harness assembly and complex pre

### **Wire Harness Manufacturer , Electro Technik , UK**

Electro-Technik are wire harness manufacturers, focusing on the construction of cable and wiring harnesses, electromechanical assembly, bespoke box builds

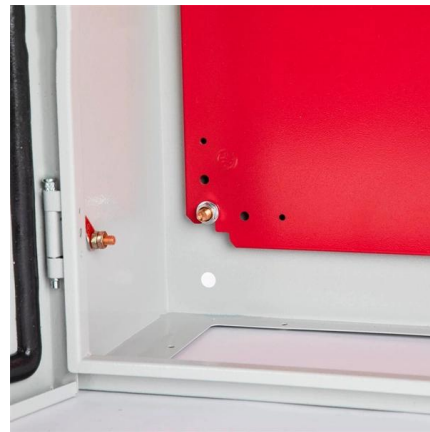

### **ITPro Today, Network Computing, IoT World Today combine**

For more details about the Informa TechTarget combination, we invite you to read the company's press release and explore our combined portfolio of publications. Together, we are

### **Permanoid**

Since our formation in 1939 we have been building on our extensive experience in cable design, manufacture and polymer technology to



bring you one of the finest ranges of cable available in the

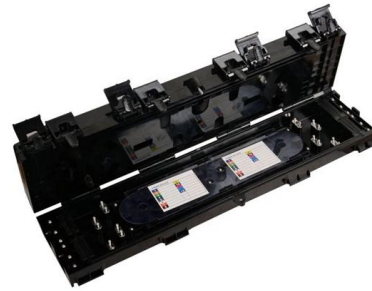

### Wiring Harnesses & Cable Assembly Manufacturers , WH Kemp

WH Kemp, the longest serving wiring harnesses, cable assembly, control panels & potting manufacturers in the UK. Serving our sector for 54

### Wire and Cable Manufacturers , Encore Wire Corporation

At Encore Wire, we are unlike any other wire company. We always put our customers first, value the future of our planet, our resources, our products and

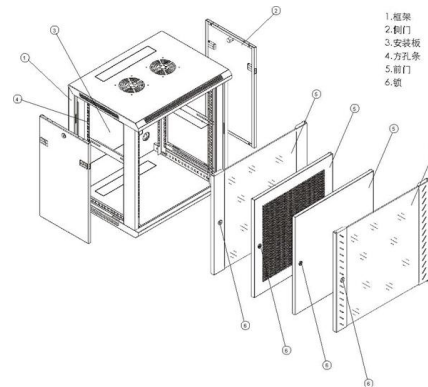

### Wire & Cable Manufacturing Systems , Bartell Machinery

Since its founding, Bartell has been a fixture in the wire and cable industry. Our focus has been to deliver robust rotating solutions based on an expertise of shaping, winding and twisting wire and cable.





## All American Balers & Used Balers Olympic Wire

New Balers & Used Balers Serving All Of The United States. Located In Costa Mesa, California. Best Balers & Baler Parts Over 36 Years. #1 With Companies



### Huijue engineering specific Fiber optic

HJ GROUP offers a wide variety of product types for you to choose from.



## Sell Your Wire and Cable Machinery

Our Trade-In Program opens up new opportunities for companies that are expanding their production, implementing new technologies, or replacing machinery. This option allows you to be more

## Cable Protectors & Wire Management

Cable protectors, Cord Covers and Wire Management products help organize messy cables, reduce tripping hazards, and adds protection to your cables.

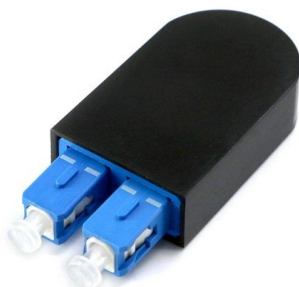

## Welcome to Loos & Co., Inc.

Explore Loos & Co., Inc., a global leader in mission-critical wire and rope manufacturing with 65+ years of expertise in high-performance cables and



## Front page

British Cables Company is unique by any standards. Not only have we manufactured cables here in Blackley, Manchester since 1895, but also we are evolving into



## Advanced Cable Machinery & Wire Manufacturing Equipment

JOC Machinery's professional cable manufacturing equipment delivers superior performance for wire drawing, cable extrusion, and complete

## AmWire , Top Electrical Wire & Cable Supplier Philippines

AmWire is the leading electrical wire supplier & manufacturer in the Philippines, offering high-quality cables and wires. Contact us for reliable wholesale electrical cables and wire solutions today!



## Wire and Cable Market Size Report & Industry Trends,

The Wire And Cable Market worth USD 245.44 billion in 2026 is growing at a CAGR of 5.17% to reach USD 315.78 billion by 2031. Prysmian



## Wire & Cable Machinery

Serving the Wire Industry for over 100 Years, Entwistle has been Designers and Builders of the most extensive line of quality Wire and Cable Equipment,



## Wire & Cable Machinery

Wire & Cable Machinery Serving the Wire Industry for over 100 Years, Entwistle has been Designers and Builders of the most extensive line of quality Wire and Cable Equipment, Entwistle machines are

## Best Electrical wires and cables manufacturers in India

About RR SHRAMIK We are the leading manufacturer and supplier of quality winding wires in the electrical equipment industry. Our products are utilized in various





## Top 10 Wire And Cable Manufacturers and Suppliers in

Wire and cable companies play a vital role in powering industrial, commercial, and residential infrastructure across the U.S. From traditional power



## UK Wiring Harness & Cable Assembly Manufacturer Quality

Discover the leading UK wiring harness & cable assembly manufacturer known for quality and rapid service in the industry.

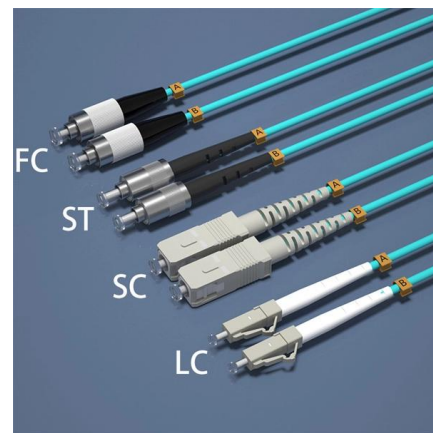

## Industrial Wire and Cable

Industrial operations require specialized wire and cable solutions that meet the demands of both day-to-day and unique projects. Wesco offers wire and cable



## Harness Testers

At Cirris, we empower businesses with progressive cable and harness test systems. Our high-quality equipment and software guarantee your electrical assemblies'



## Extruders | Rotating Equipment | Cable Rewinders | Braiders

Cable Manufacturing Wire & Plastic Machinery Corp. is the world's largest reseller of second-hand wire, cable and optical fiber equipment. We are a full service company with knowledgeable sales and

## Wire and Plastic Machinery Corporation

Wire, Cable, & Optical Fiber Machinery Wire & Plastic Machinery Corp. is a global equipment supplier offering high quality solutions for wire, cable, and optical fiber manufacturing. We have a



## CAI

We manufacture a huge range of ribbon cable assemblies, in various pitch sizes, and conductor counts to suit your specific needs. Designed to be compact and





## Contact Us

---

For datasheets, pricing, or custom telecom energy solutions, please visit:  
<https://koskolong.co.za>